



Off-Cut Remover

Hektor 2/3

Spare Parts List for the following products

Description	Type
Off-Cut Remover	Hektor 2
Off-Cut Remover	Hektor 3

Edition: 9/2008 - Part No. 9008721

Copyright

This documentation as well as translation hereof are property of cab Produkttechnik GmbH & Co. KG.

The replication, conversion, duplication or divulgement of the whole manual or parts of it for other intentions than its original intended purpose - in particular the procurement of spare parts for products sold by cab – demand the previous written authorisation by cab.

Editor

Regarding questions or comments please contact cab Produkttechnik GmbH & Co. KG.

Topicality

Due to the constant further development of our products discrepancies between documentation and product can occur.

Please check www.cabgmbh.com for the latest update.

Terms and conditions

Deliveries and performances are effected under the "General conditions of sale of cab"

Germany

cab Produkttechnik
GmbH & Co KG
Postfach 1904
D-76007 Karlsruhe
Wilhelm-Schickard-Str. 14
D-76131 Karlsruhe
Telefon +49 721 6626-0
Telefax +49 721 6626-249
www.cab.de
info@cab.de

France

cab technologies s.a.r.l.
Z.A. Nord du Val de Moder
F-67350 Niedermodern
Téléphone +33 388 722 501
www.cab-technologies.fr
info@cab-technologies.fr

Spain

cab España S.L.
Josep Pla 9, 6º, 2a
E-08304 Mataró (Barcelona)
Teléfono +34 937 414 605
Teléfax +34 937 414 731
www.cab.de
info@cabsl.com

USA

cab Technology Inc.
90 Progress Avenue Unit #2
Tyngsboro MA, 01879
Phone +1 978 649 0293
www.cabtechn.com
info@cabtechn.com

South Afrika

cab Technology (Pty.) Ltd.
14, Republic Road
2125 Randburg
Phone +27 11-886-3580
Fax +27 11-789-3913
www.cab.de
info@cabtech.co.za

Asia 亞洲分公司

希愛比科技股份有限公司

cab Technology Co, Ltd.

台灣台北縣板橋市

民生路一段33號十九樓之一

19F-1, No. 33, Sec. 1,

Min Sheng Road

Panchiao 220,

Taipei, Taiwan, R.O.C.

電話 Phone +886 2 2950 9185



網址 www.cabasia.net

詢問 cabasia@cabgmbh.com



Other subsidiaries on request









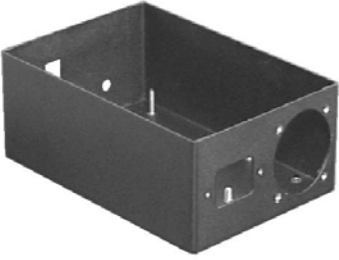

	8932137.001 8932138.001 8932139.001 8932144.001 8932191.001
	8932122.001 8932123.001 8932124.001 8932125.001 8932141.001
	5909015.001





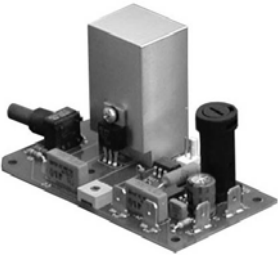









	5902159.001
	8932171.001
	8932188.001
	5902002.001

	Hektor 2	8932129.001
	Hektor 3	-
	Hektor 2	-
	Hektor 3	8932692.001

	8932102.001
	5903053.001
	5903088.001
	5903035.001
	8932189.001
	5905422.001
	5905423.001
	8932979.001
	5905465.001
	5902316.001

	8932182.001
	5905423.001
	5905261.001
	5905256.001
	5905427.001
	5904507.001
	5909003.001

	Hektor 2 - Hektor 3 8932694.001
	Hektor 2 - Hektor 3 8932685.001
	Hektor 2 - Hektor 3 5902157.001
	Hektor 2 - Hektor 3 5917205.001
	Hektor 2 - Hektor 3 5902029.001
	Hektor 2 - Hektor 3 5917193.001
	Hektor 2 - Hektor 3 5905143.001
	Hektor 2 - Hektor 3 5902505.001
	Hektor 2 - Hektor 3 5903004.001
	Hektor 2 - Hektor 3 8932975.001
	Hektor 2 - Hektor 3 5900514.001
	Hektor 2 - Hektor 3 8932682.001
	Hektor 2 - Hektor 3 8932683.001

	Hektor 2 - Hektor 3 5534176.001
	Hektor 2 - Hektor 3 5903033.001
	Hektor 2 - Hektor 3 5902510.001
	Hektor 2 - Hektor 3 5903011.001
	Hektor 2 - Hektor 3 8932962.001
	8932697.001
	Hektor 2 5903005.001 Hektor 3 5903520.001
	Hektor 2 5902034.001 Hektor 3 5902033.001
	5905399.001
	8932978.001
	5905400.001
	5905401.001
	5905423.001
	8932961.001

Spare Parts Register

Pos.	Figure/Page	Part No.	Description	PU	SPR				Serial No.	
									from	to
1		4	5534176.001	Cable	1					
2		4	5900514.001	Spacer Bushing PA M3x8	10					
3	3		5902002.001	Screw DIN912-M4x10	10					
4		4	5902029.001	Screw DIN7991-M3x8	10					
5		4	5902033.001	Screw DIN7985-M4x12	10					
6		4	5902034.001	Screw DIN7985-M4x8	10					
7		4	5902157.001	Screw DIN7985-M3x12	10					
8	3		5902159.001	Screw DIN912-M5x12	10					
9	3		5902316.001	Flush Screw DIN7991-M6x60	10					
10		4	5902505.001	Nut DIN934-M3	10					
11		4	5902510.001	Nut DIN934-M4	10					
12		4	5903004.001	Washer DIN125-A3.2	10					
13		4	5903005.001	Washer DIN9021-4.3	10					
14		4	5903011.001	Toothed Washer DIN6797-A4.3	10					
15		4	5903033.001	Washer DIN125-A4.3	10					
16	3		5903035.001	Washer DIN988-8x14x1.0	10					
17	3		5903053.001	Washer DIN988-8x14x0.1	10					
18	3		5903088.001	Washer DIN988-8x14x0.3	10					
19		4	5903520.001	Washer DIN7349-4.3	10					
20	3		5904507.001	Set Screw DIN916-M4x10	10					
21		4	5905143.001	Power Switch	1				D	
22	3		5905256.001	Threaded L-Fitting	1					
23	3		5905261.001	Sealing Ring	10			C	D	
24		4	5905399.001	Coupling Plug	1					
25		4	5905400.001	Foot Switch	1			C	D	
26		4	5905401.001	Silencer	1			C	D	
27	3		5905422.001	Short Stroke Cylinder	1					
28	3	4	5905423.001	Push-in/threaded Fitting	1					
29	3		5905427.001	Pressure Regulator	1				D	
30	3		5905465.001	Push-in/threaded Fitting M14x1	1					
31		4	5917193.001	Power Filter	1				D	
32		4	5917205.001	Power Socket	1				D	
33	3		8932102.001	Adapter cpl.	1					
34	3		8932122.001	Blade 1.5 L	1	A	B	C	D	
35	3		8932123.001	Blade 2.0 L	1	A	B	C	D	
36	3		8932124.001	Blade 2.5 L	1	A	B	C	D	
37	3		8932125.001	Blade 3.0 L	1	A	B	C	D	
38	3		8932129.001	Pane	1					
39	3		8932137.001	Blade 1.5 T	1	A	B	C	D	
40	3		8932138.001	Blade 2.0 T	1	A	B	C	D	
41	3		8932139.001	Blade 2.5 T	1	A	B	C	D	
42	3		8932141.001	Blade 2.4 L	1	A	B	C	D	
43	3		8932144.001	Blade 3.0 T	1	A	B	C	D	
44	3		8932171.001	Matrix	1	A	B	C	D	
45	3		8932182.001	Baseplate	1					
46	3		8932188.001	Holder cpl.	1			C	D	
47	3		8932189.001	Plate	1					
48	3		8932191.001	Blade 2.4 T	1	A	B	C	D	
49		4	8932682.001	Cable	1					
50		4	8932683.001	Cable	1					
51		4	8932685.001	Bonnet	1					
52	3		8932692.001	Adapter cpl.	1					
53		4	8932694.001	Distance Bolt	1					
54		4	8932697.001	Baseplate cpl.	1					
55		4	8932961.001	Tube cpl.	1					
56		4	8932962.001	Cable	1			C	D	
57		4	8932975.001	PCB Rotation Speed Control assem.	1		B	C	D	
58		4	8932978.001	Tube	1					
59	3		8932979.001	Tube	1					

PU Package unit

SPR Recommendation

A - wearing parts and accessories

B - recommended spare parts for quick repair

C - recommended spare parts for distributors

D - recommended spare parts for central stores

Technical Documents

Pos.	Figure/Page	Part No.	Description	PU	SPR	Serial No.	
						from	to
60		9008118.001	Operator's Manual Hektor 2/3 G/E	1			

Packaging/Accessories

Pos.	Figure/Page	Part No.	Description	PU	SPR	Serial No.	
						from	to
61	3	5909003.001	Key DIN911-4	1			
62	3	5909015.001	Key DIN911-3	1			
63		8932133.001	Packaging	1			

PU Package unit
 SPR Recommendation
 A - wearing parts and accessories
 B - recommended spare parts for quick repair

C - recommended spare parts for distributors
 D - recommended spare parts for central stores