



THE WORLD LEADER IN FUME EXTRACTION TECHNOLOGY

3D PrintPRO 2

3D PRINTING

Last Updated on 29.08.2018



For open framed 3D printers.

The BOFA 3D PrintPRO 2 is a low cost unit, which extracts fumes generated by an open framed 3D printer without causing the filament deposition area to be cooled.

It has the benefits of low noise level and minimal power consumption. Each unit is supplied with a connection hose, 'Stay Put' arm and conical shaped funnel.

Print your own extendable manifolds 3D drawing files can be found at: bofainternational.com/en/print-your-own

Technology



HEPA filter



Advanced carbon filter (ACF) technology



Multi voltage sensing unit (MVS)



ProTECT service plan



SureCHECK quality standard

Key features of the 3D PrintPRO 2

Filter change indicator
Standard

Hose kit included
Standard

Powder coated for durability
Standard

Compact size
Standard

3 level filtration - pre, HEPA and chemical filters
Standard

Low noise level
Standard

Small footprint
Standard

24V remote stop/ start interface
Optional

Contact BOFA at <https://bofainternational.com/en/contact/>

<https://bofainternational.com/en/portal/datasheets/3d-printpro-2/>



Technical specification

- 1. Filter change indicator
- 2. On / Off switch
- 3. Feet
- 4. Power cable inlet
- 5. Lid fastening latches
- 6. Hose inlet connections - 50mm
- 7. Exhaust outlets

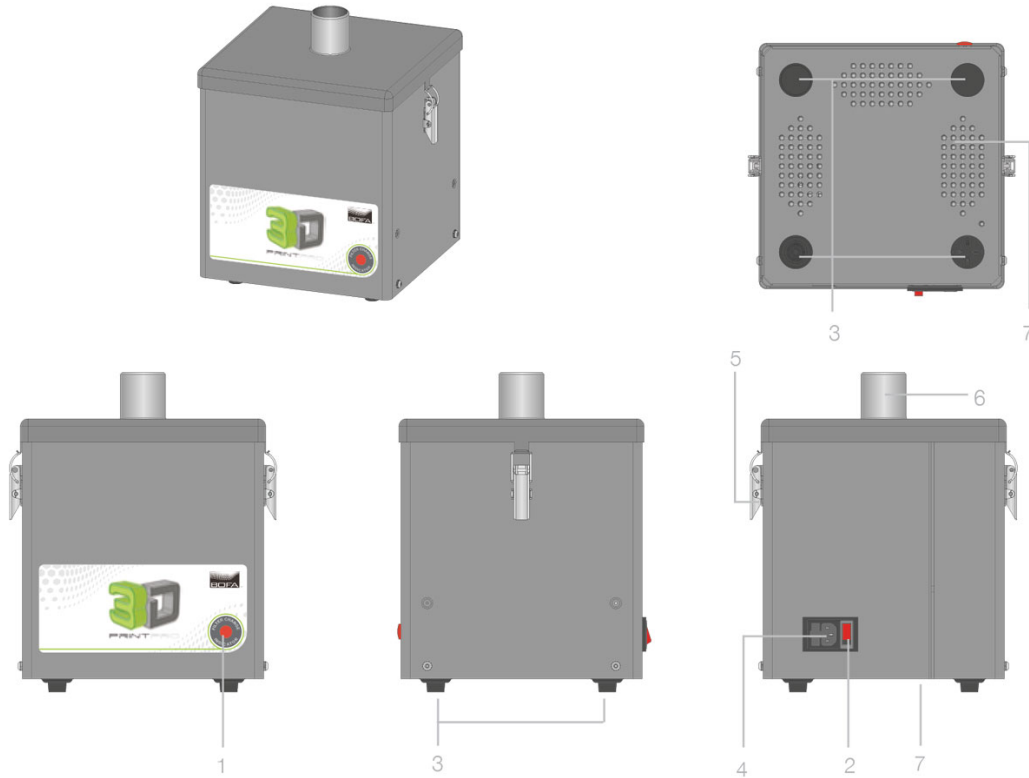

Hose kit technical specification

- 1. Funnel
- 2. 50mm 'Stay Put' arm
- 3. Fliptop mount
- 4. Table bracket
- 5. 2 x 'G' clamps
- 6. 60mm Flexible Hose
- 7. 2 x Jubilee Hose
- 8. Shut off valve

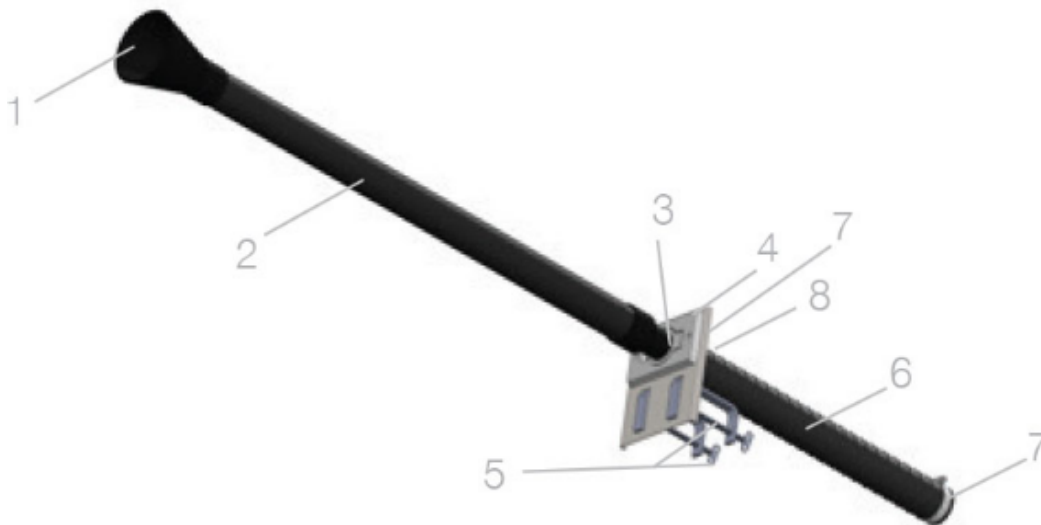

Airflow through filters

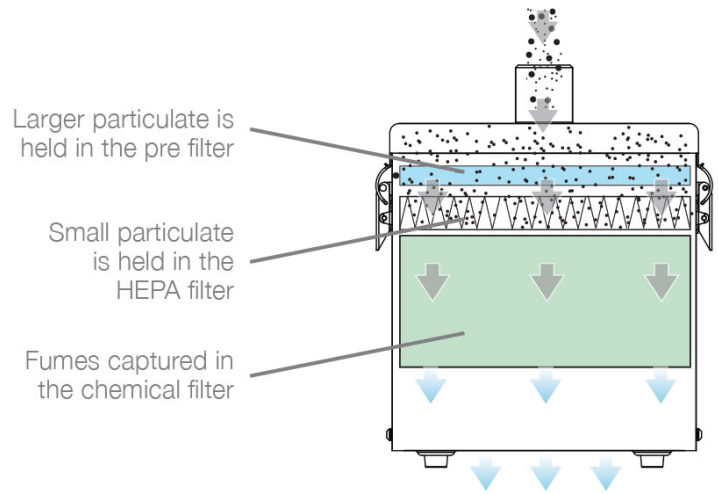
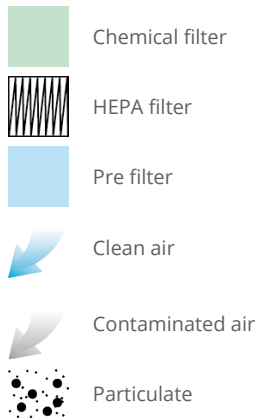

Unit part numbers

Model	Part no.	Options
3D PrintPRO 2 Powder coated	L5444-0000	A2001

Replacement filter part numbers

Model	Pre filter	Combined HEPA/Gas filter
3D PrintPRO 2	A1030102	A1030099

Technical data

	EU	US
Dimensions (HxWxD)	330 x 290 x 270mm	12.99 x 11.42 x 10.63"
Cabinet construction	Powder coated mild steel	Powder coated mild steel
Airflow / pressure	45m ³ /hr	26.5cfm
Electrical data	230v 1ph 50/60Hz Full load current: 0.2 amps	115v 60/50Hz Full load current: 0.2 amps
Noise level	< 44dBA (at typical operating speed)	< 44dBA (at typical operating speed)
Weight	7.8kgs	17lbs
Approvals	CE	CE

Pre filter specifications

Filter media	Glass fibre
Filter media construction	Pad
Filter efficiency	96% @ 2 microns

Combined HEPA / Gas filter specifications

HEPA filter media	Glass fibre
HEPA media construction	Maxi pleat construction with webbing spacers
Gas filter	Treated activated carbon

Combined HEPA / Gas filter specifications

Filter housing	Zintec mild steel
Filter efficiency	99.997% @0.3 microns

Datasheet correct at time of publishing. For specific applications, please contact us for details.

