

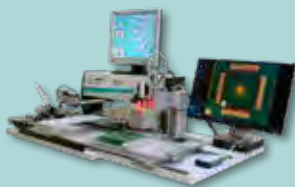

## Product overview



Innovation and quality made in Germany



## Contents

placeALL®520.....	6
placeALL®620.....	8
placeALL®620L.....	10
placeALL®610XL.....	12
Axis drive and control.....	14
Centering systems.....	15
User friendly Software.....	16
Simple project development.....	17
Advanced working assistance.....	18
Software modules.....	19
Feeder systems.....	23
Conveyor systems.....	28
Dispensing systems.....	29
Accessories.....	30
Applications.....	32
Special solutions.....	34



LM900.....	38
LM901.....	40
LMinline.....	42
LMdispense.....	44
SM902.....	46
SM902 <i>professional</i> .....	48
Multi Placer MP904.....	50
Software.....	53
System options.....	55
Feeder and storage systems.....	57
SM902 systems accessories.....	68
Accessories.....	70

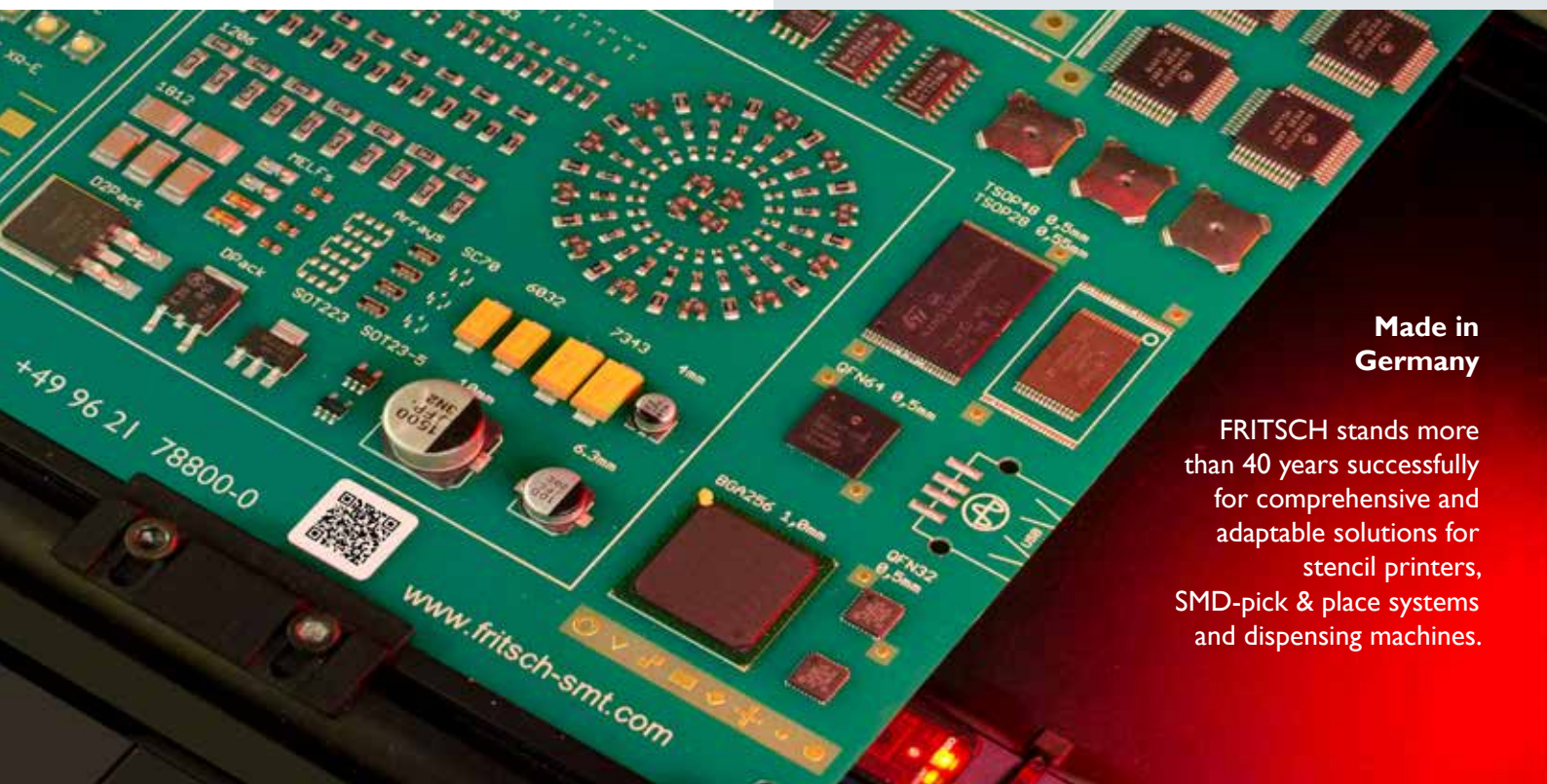

**Made in  
Germany**

FRITSCH stands more than 40 years successfully for comprehensive and adaptable solutions for stencil printers, SMD-pick & place systems and dispensing machines.



dispenseALL420 .....	74
Overview .....	75
Drive systems .....	76
Dispensing heads .....	77
Dispensing valves .....	78
Applications .....	80
User-friendly Software .....	82
Simple project developement .....	83
Software options .....	84
Advanced working assistance .....	85
Conveyor systems .....	86
Accessories .....	87
Technical details .....	89



printALL005 .....	92
printALL005L .....	93
System options .....	94
printALL210 .....	96
Construction .....	98
System options .....	99
Options .....	100
Accessories .....	102



Batch Reflow Systems .....	108
Features .....	110
Options .....	111
Inline Reflow Systems .....	112
Features, options .....	113
References .....	114



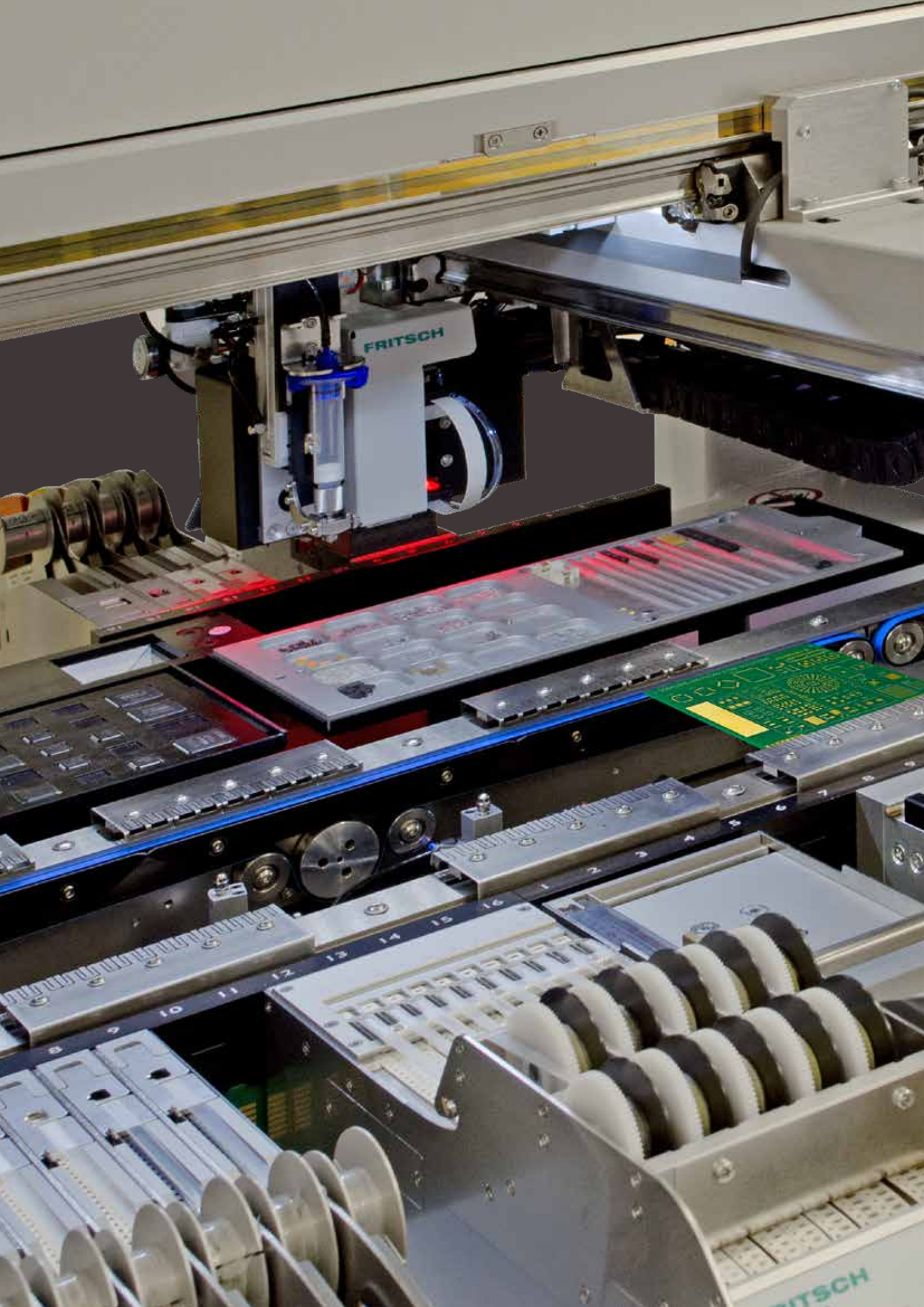



# placeALL®

The Fritsch **placeALL®** is the standardized platform for flexible, high-precision and cost-effective assembly of electronic components in the area of prototypes, small and medium-sized series. All machine types have the same software base for setting up, customizing and manufacturing. Due to the company's own vertical range of manufacture, customer-specific applications can be implemented quickly.

All **placeALL®** pick & place systems have been developed for the flexible production of a wide variety of SMD projects.

Attention was paid to short project changeover times, which are implemented using intelligent feeders and barcode support, among other things. The modular structure makes it possible that the majority of the available options can be retrofitted at the customer.





The **placeALL®520** is the smallest fully automatic system from FRITTSCH. The modular structure and a multitude of options make it the ideal machine for the production of prototypes and small series. Due to the wide range of components from chips size 0201, FP components and BGAs up to a pitch of 0.4 mm and max. 70 x 70 mm outside dimensions can even be the most complex projects can be manufactured flexibly. Up to 200 possible feed positions and intelligent software reduce the changeover times, which affect productivity, especially with small lot sizes. The freely configurable assembly room can be used both as a pure circuit board area and for feeding components from the tray, belt section and bulk material. The integration in a line, the processing of at least 40 freely configurable positions in the assembly area, flexible circuit carriers or the application of paste using a dispensing valve can be optionally retrofitted.





# Overview

## Examples for configuration placeALL®520

Feeder slots single 8 mm or 12 mm tape FEEDER / many 8 mm block FEEDER

Feeder slots 100 / 200

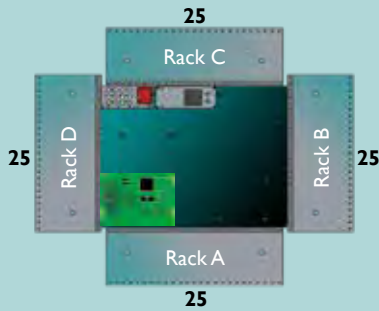

Feeder slots 50 / 100

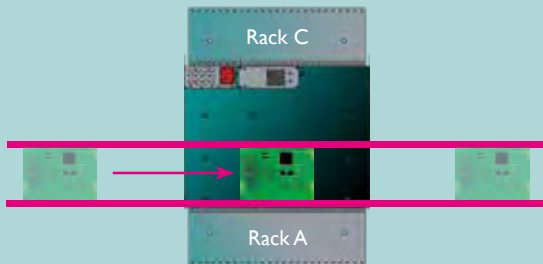

Feeder slots 75 / 150

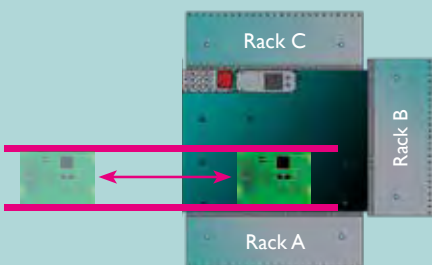

Feeder slots 75 / 150

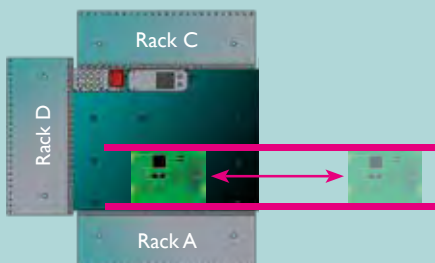

**SMD fully automatic Pick & Place system** with one Pick & Place head with lasercentering for 0201 chips up to 32 x 32 mm, pitch 0,6 mm

placement speed up to 4000 (3200 / IPC9850) cp/h max.  
100 slots - 200 feeder positions for reel 8 mm

max. board size: 520 x 430 mm  
placement area adaptably configureable

## Range of applications

Pick & Place and dispensing of prototypes and small series

## Feeding units

Feeding of components as tape, stick, tape-strip, tray and loose components

Integration of customized feeders is possible

## Features

- Bottom-Vision
- standalone or inline
- dividable machine frame
- max. two dispensing heads
- RCL component test up to 0201
- vacuum table for flexible circuits



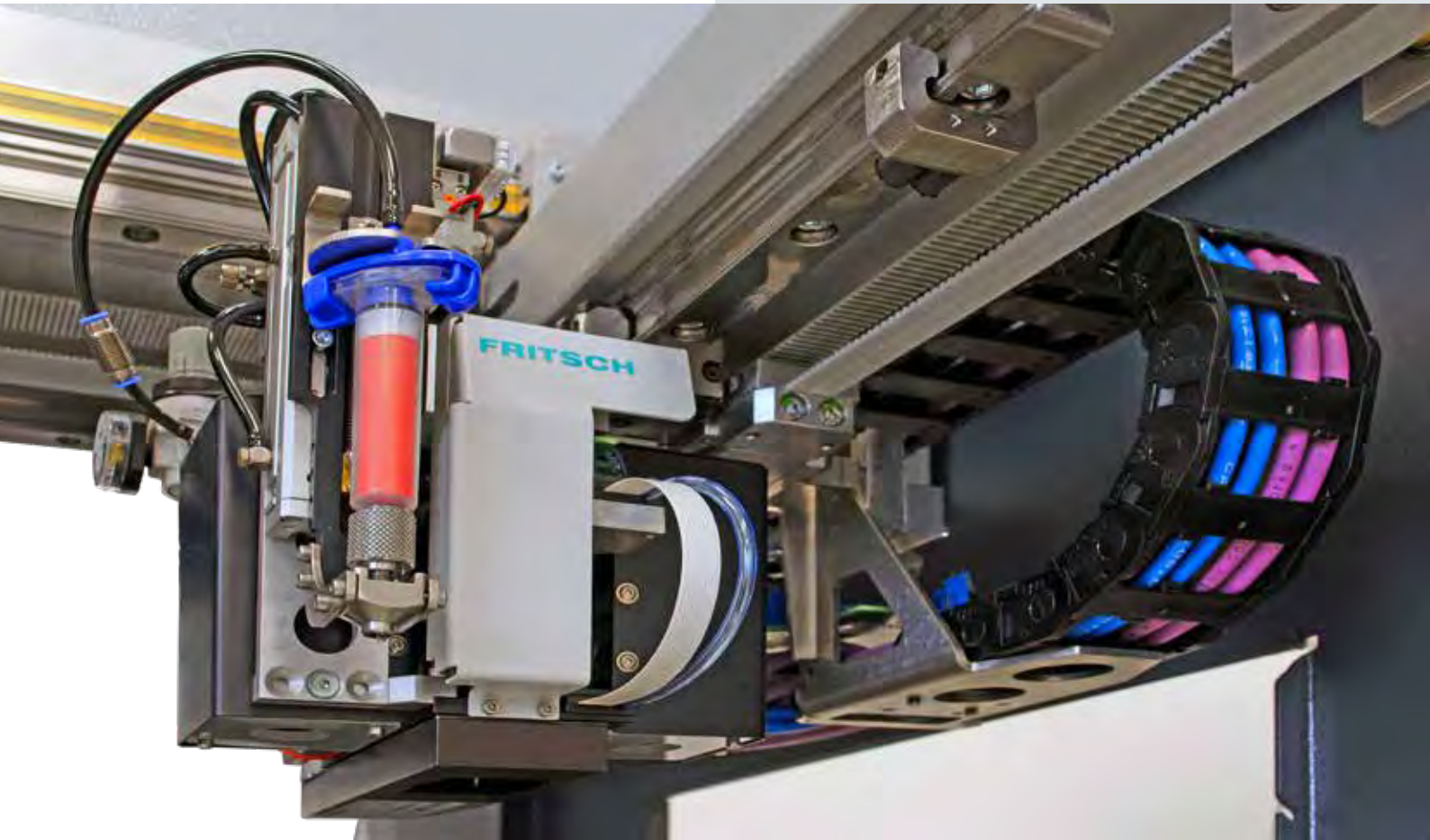

Like the **placeALL®520**, the **placeALL®620** has a modular structure and is used for the production of small series up to medium lots.

The range of components from chips type 0201, FP components and BGAs up to grid 0.3 mm and max. 70 x 70 mm outer dimensions can be processed safely. An optional second placement head can even increase production by up to 40 %.

208 possible feed positions and intelligent software reduce the machine setup. The “smartLINE” combination with dispensing or other automatic placement machines not only increases the feeder capacity but above all the output of the machine.



# Overview

## Examples for configuration placeALL®620

Feeder slots single 8 mm or 12 mm tape FEEDER / many 8 mm block FEEDER

Feeder slots 108 / 208

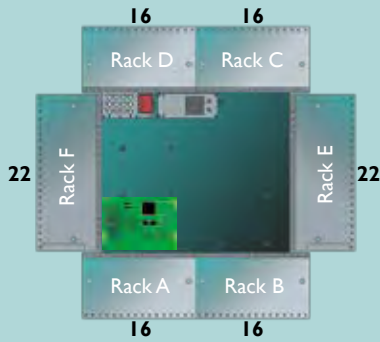

Feeder slots 64 / 124

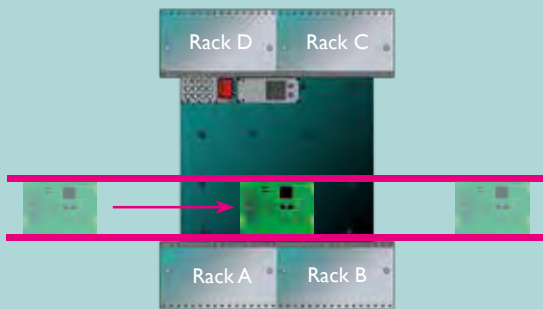

Feeder slots 86 / 166

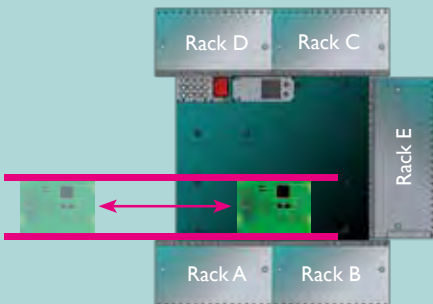

Feeder slots 86 / 166

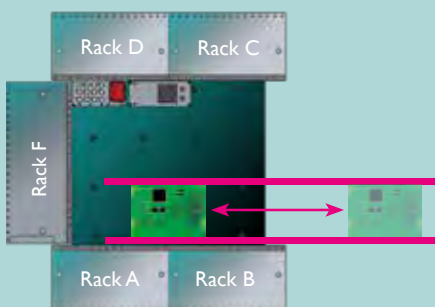

**SMD fully automatic Pick & Place system** with one Pick & Place head with lasercentering for 0201 chips up to 22 x 22 mm (alt. up to 32 x 32 mm) pitch 0,6 mm

placement speed up to 10500 (two heads)  
6000 (4600 / IPC9850) cp/h max. 108 slots - 208 feeder positions for reel 8 mm

max. board size: 520 x 430 mm  
placement area adaptably configureable

## Range of applications

Pick & Place and dispensing of small series up to medium lot sizes

## Feeding units

Feeding of components as tape, stick, tape-strip, tray and loose components

Integration of customized feeders is possible

## Features

- Bottom-Vision
- standalone or inline
- dividable machine frame
- max. 2 Pick & Place heads
- max. 2 dispensing heads
- RCL component test up to 0201
- vacuum table for flexible circuits





# placeALL®620L



The **placeALL®620L** has a wider placement space than the **placeALL®620**. As a result, up to 284 feed positions and a maximum of 6 trays can be made available for production. The entire assembly room can also be used to assemble several small or large circuit boards (up to 910 x 430 mm).

The available hardware options and software modules as well as the feeder concept are the same as for the **placeALL®520 / 620**. This compatibility offers the easy possibility to work with several machines in parallel or to chain them.





# Overview

## Examples for configuration placeALL®620L

Feeder slots single 8 mm or 12 mm tape FEEDER / many 8 mm block FEEDER

Feeder slots 144 / 284

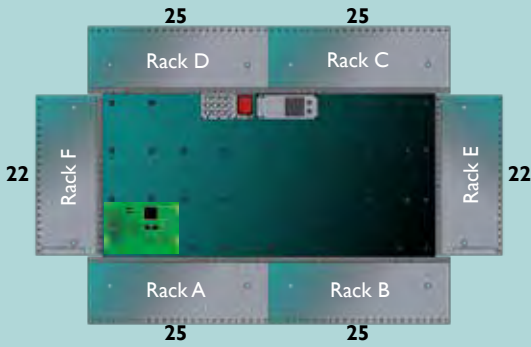

Feeder slots 100 / 200

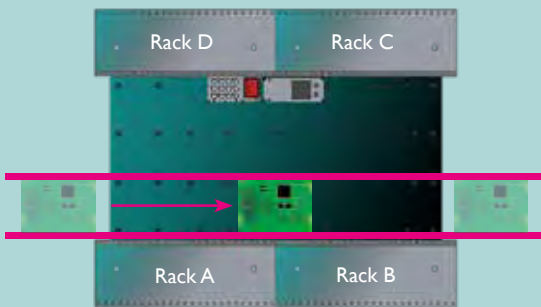

Feeder slots 122 / 242

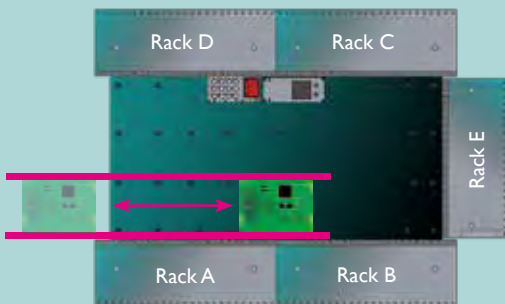

Feeder slots 122 / 242

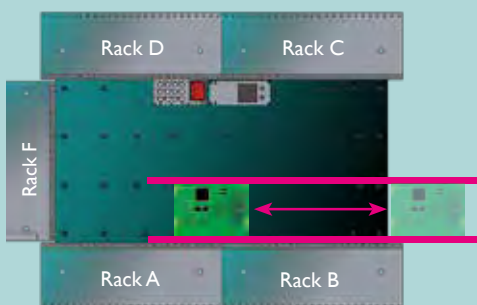

**SMD fully automatic Pick & Place system** with one Pick & Place head with lasercentering for 0201 chips up to 22 x 22 mm (alt. up to 32 x 32 mm) pitch 0,6 mm

placement speed up to 10500 (two heads) 6000 (4600 / IPC9850) cp/h max. 144 slots - 284 feeder positions for reel 8 mm

max. board size: 910 x 430 mm  
placement area adaptably configureable

## Range of applications

Pick & Place and dispensing of small series up to medium lot sizes

## Feeding units

Feeding of components as tape, stick, tape-strip, tray and loose components

Integration of customized feeders is possible

## Features

- Bottom-Vision
- standalone or inline
- dividable machine frame
- max. 2 Pick & Place heads
- max. 2 dispensing heads
- RCL component test up to 0201
- vacuum table for flexible circuits



# placeALL® 610XL



The **placeALL® 610XL** offers the largest assembly table in the placeALL® series. Its dimensions also enable the largest projects to be equipped. In addition to the pure surface for printed circuit boards, it offers plenty of space for numerous trays. Up to 346 different feed positions can be provided. The available depth also allows the integration of an inline system in the front area of the machine, as well as parallel feed units from the side. Even inline, there are still 262 feed positions and space for several trays. Customized product receptacles or vacuum tables for large, flexible circuit carriers can be integrated.



# Overview

## Examples for configuration placeALL® 610XL

Feeder slots single 8 mm or 12 mm tapeFEEDER /  
many 8 mm blockFEEDER  
Feeder slots 176 / 346

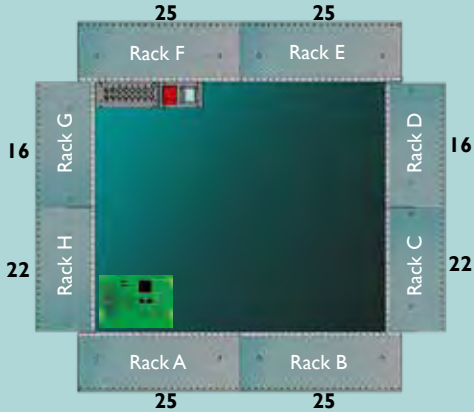

Feeder slots 132 / 262

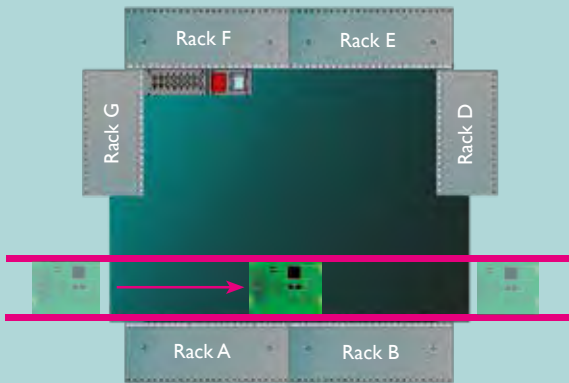

Feeder slots 154 / 304

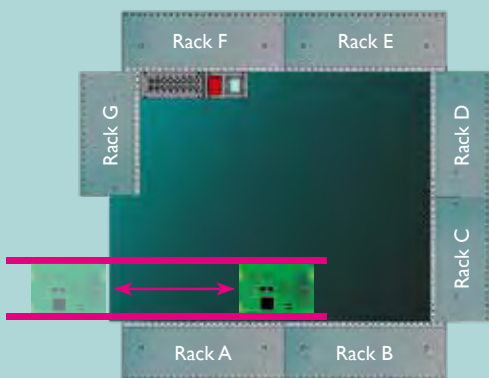

Feeder slots 154 / 304

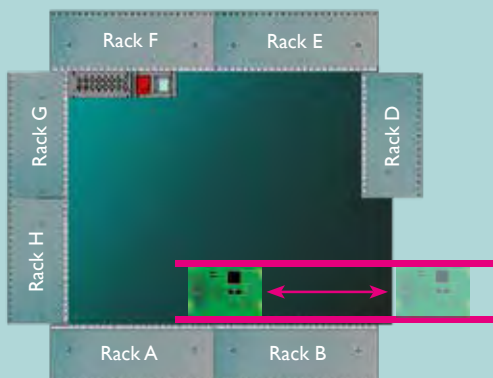

**SMD fully automatic Pick & Place system** with one Pick & Place head with lasercentering for 0201 chips up to 22 x 22 mm (alt. up to 32 x 32 mm) pitch 0,6 mm

placement speed up to 10500 (two heads)  
6000 (4600 / IPC9850) cp/h  
max. 176 slots - 346 feeder positions for reel 8 mm

max. board size: 910 x 760 mm  
placement area adaptably configureable

## Range of applications

Pick & Place and dispensing of small series up to medium lot sizes

## Feeding units

Feeding of components as tape, stick, tape-strip, tray and loose components

Integration of customized feeders is possible

## Features

- Bottom-Vision
- standalone or inline
- max. 2 Pick & Place heads
- max. 2 dispensing heads
- RCL component test up to 0201
- vacuum table for flexible circuits





# Axis drive and control

## Belt transmission

The axis of the **placeALL**<sup>®</sup> are constructed with belt transmission which is driven by modern DC motors in combination with a high-resolution linear measurement system. This system is mounted alongside of the axis.

The axis and assembling heads of the **placeALL**<sup>®</sup> range are weight-optimized constructed to minimize the accelerating force. Therefore the use of a belt drive is possible and there's no need to build in a spindle drive with shaft joint.

This is an enormous advantage for cost of ownership and offers a high potential of cost reduction in service and repair according to the spindle drive.

The axis of the **placeALL**<sup>®</sup> combine the both advantages of these two systems in an optimal way: High dynamic of belt transmission added to the exact linear measurement system.

The Encoder's high solution of 0.5  $\mu\text{m}$  at **placeALL**<sup>®</sup>520 and **placeALL**<sup>®</sup>620 is optimal completed with an axis-controller with the scanning rate of 100  $\mu\text{m}$  per axis. Therefore this highly dynamic movement can be carried out exactly.

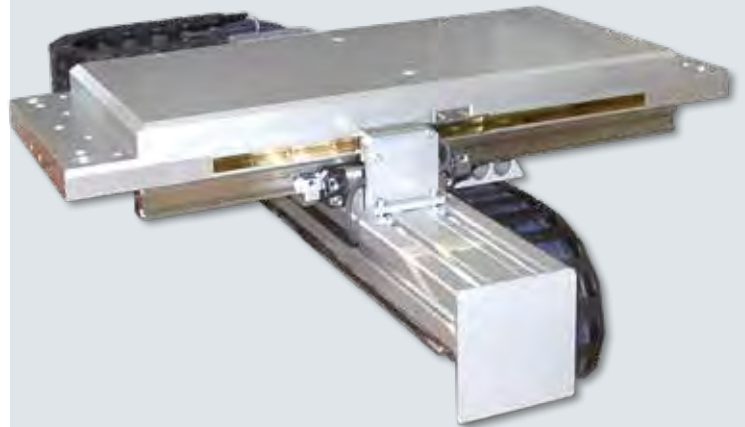

X/Y-Axis drive and control PA620



# Centering systems

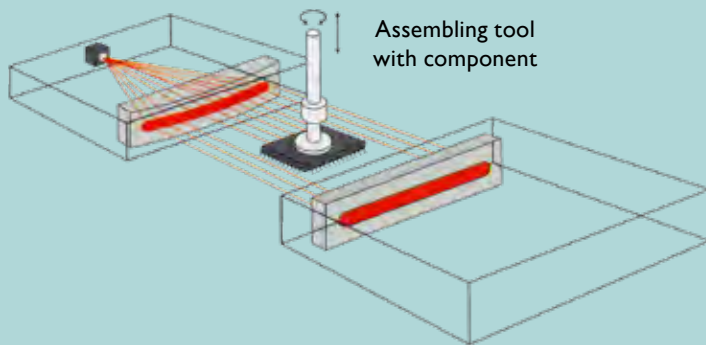

## Laser Centering

The laser centering is directly installed on the assembly head. The component which has to be centered is while rotating measured by the laser centering. Its shadow on the opposite side is analysed and a contactless fast centering happens. The component capability ranges from 0201 chips up to components with dimensions of 32 x 32 mm and Fine Pitch to 0.4 mm at PA520.

BGAs can be centered in this way, too.

The laser centering is also a method to determine the component dimensions like length, width and height.

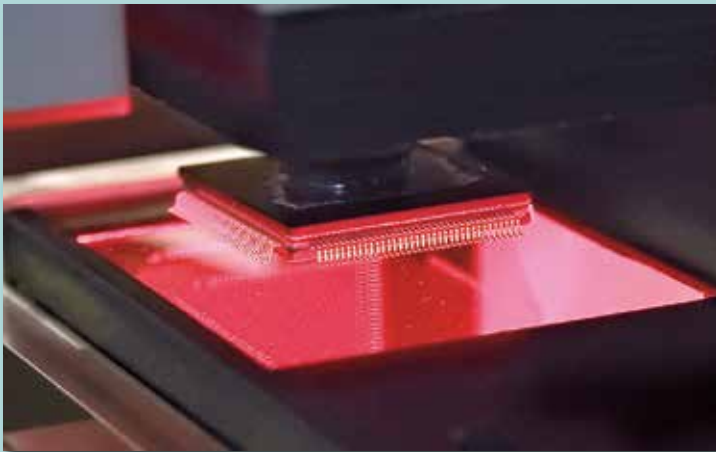

## Bottom-Vision

The bottom vision is an image recognition which measures and analyses the components that are too large for the centering at the head.

The software for image recognition determines the exact assembling position and tests the BGAs of complete balls respectively that the FPs' wires aren't deformed. These components can be selected before processing. Used are components up to 0201,  $\mu$ BGAs, 0.3 mm Fine-Pitch or special components like for example connectors.

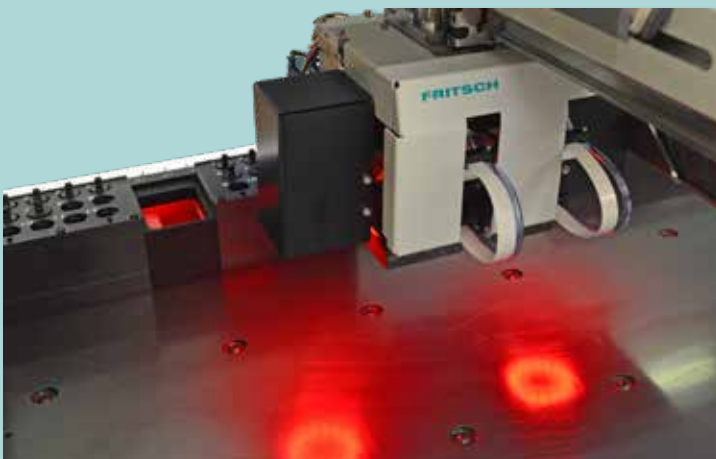

## Double head

According to the motto „grow with the times“, a second placement head and tool changer can be retrofitted to the **placeALL®620**, **placeALL®620L** and **610XL**.

This allows the placement speed to be increased up to 40 %.



# User friendly Software

## Usability and programming

The clearly laid out software guides the user step by step to his goal. To setup a new project or alter an existing one, the parameters can be simply chosen with a mouse click. There is also a detailed help menu for each function.

The smartASSISTANT monitors all user activities, gives hints and tips and shows every error source in plain text, so it is generally not necessary to consult the user manual.

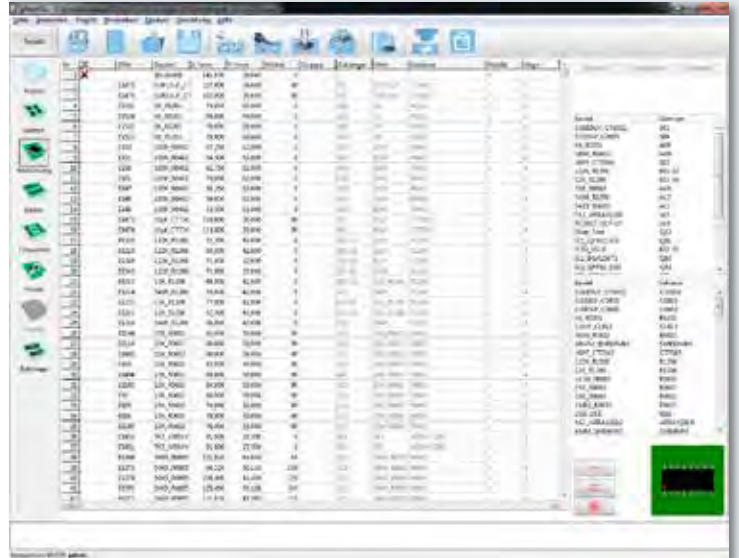

## Package library

The integrated package library contains more than 450 component models. This represents one of the largest package libraries available on the market in this class. All content can be edited or newly created.

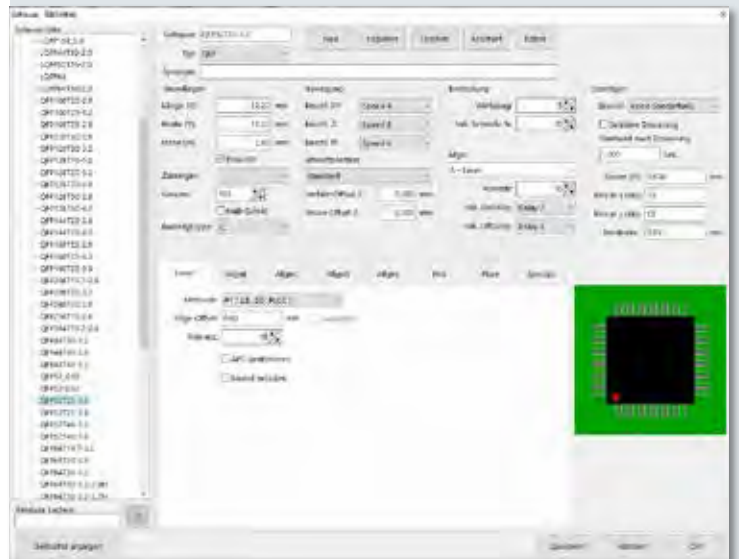

## Component Editor

If components, which are not part of the default library, need to be placed, a graphical editor is used to create a new component body in just a few steps.

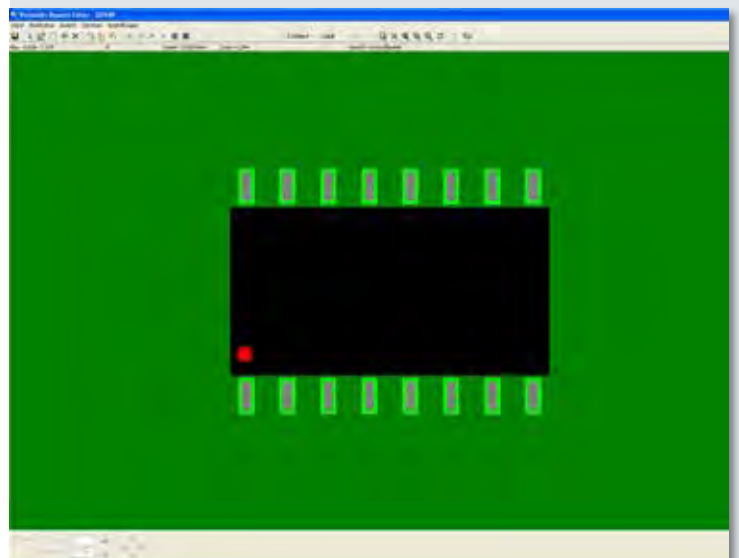



# Simple project development



## Universal CAD data converter

CAD data from any CAD system can be interfaced easily to the projects using a format editor. The conversion process is very fast and can be done offline on a separate PC. During this process the Pick&Place machine can continue to be used for its main task of placing components.

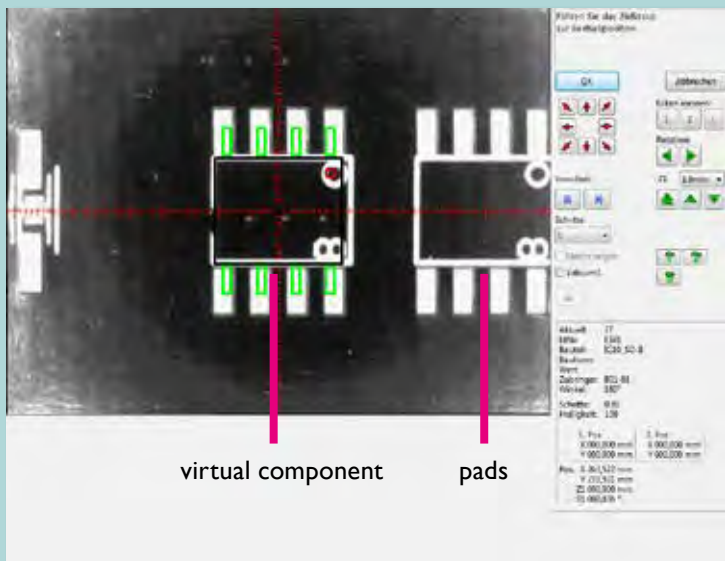

## Teach In

To create a project, the user drives the head to the particular position; a virtual component is shown as an overlay in the camera window. The virtual component can now be adjusted exactly and brought into the right position. After that, its position is logged into the Pick&Place project file.

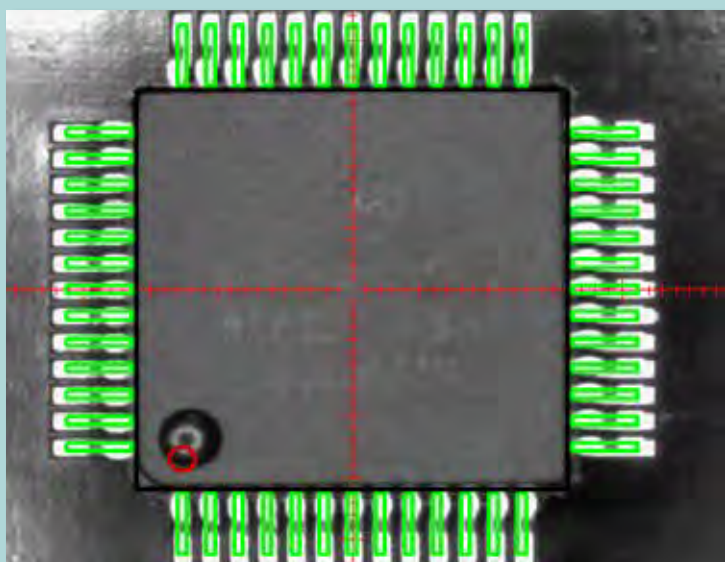

## Virtual Inspection

After acquiring the CAD data the virtual inspection can be used to simulate the Pick&Place process. The camera moves across the current circuit board. At each placing position the corresponding component is blended in virtually. The position and polarity of the component can be checked and corrected if necessary. In this way error-free prototypes can be produced in a very short time.



# Advanced working assistance

## Monitoring the placement process

To inform the user of the current status of the Pick & Place process, the circuit board is shown on the monitor. It displays virtual components one-to-one with the real assembly.

## Automatic setup control

The automatic setup control shows the result before the real assembly process starts. The image of a PCB can be used as model. Therefore it is possible to control fast and easy the result of assembling.

Components are single or grouped deactivated or deleted. The editor possibilities like moving or rotating complete the automatic setup control to a very useful tool. While the Pick & Place process the virtual plan is displayed to control the real advancement of assembling.

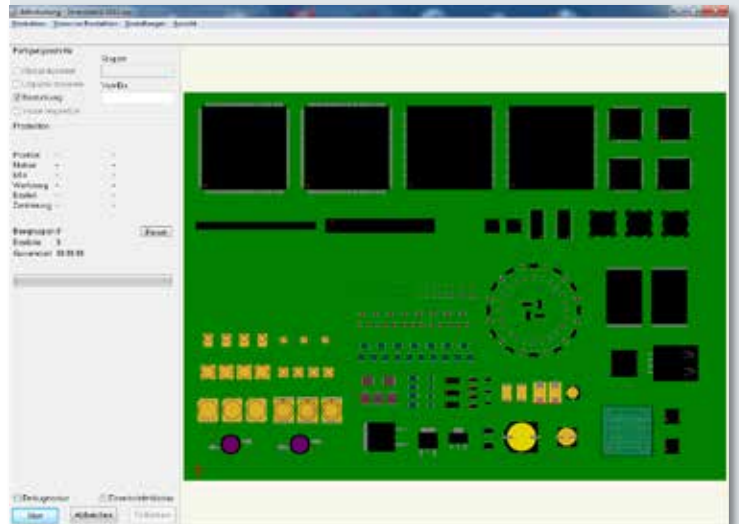

## User management

The user administration makes it possible to assign different rights to different users. The person who is able to edit programs or update component libraries can be defined, and other users can be locked out of these functions. These rights can be easily edited by clicking on the different production steps in the software.

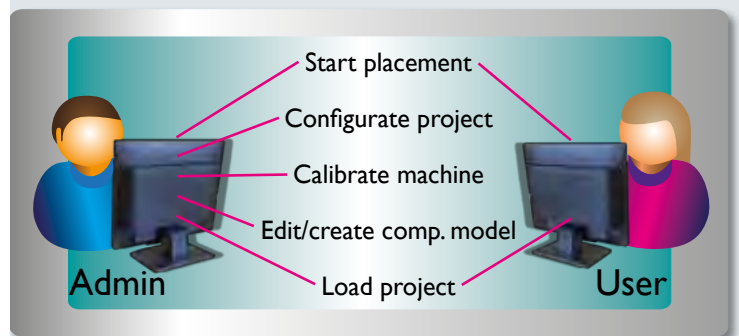

## Remote Support

In order to provide you with the best possible support, the service kit enables you to dial into the placement machine and the installed software after you have given your approval. This enables us to get an overview very quickly and to help you at short notice. The remote maintenance tool is free of charge during the warranty period.





# Software modules

## Software modules

All described software modules can be refitted to your software on demand.

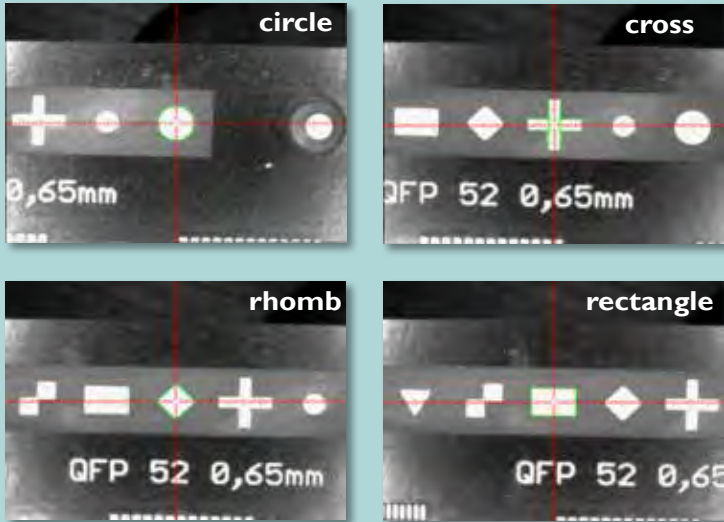

## Automatic fiducial recognition

To set up an assembly, reference marks such as crosses, circles, rhombi etc. can be read in automatically. The camera captures the exact position of the circuit board before the assembly begins.

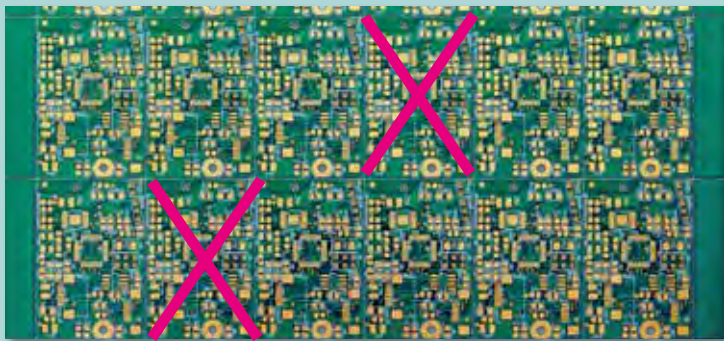

## Badmark recognition

The recognition is searching automatically for a mark on a defined position whether the PCB should be signed as bad and shouldn't be assembled. The sign is identified in cause of its brightness. Light or dark marks (made with labels, pens or ink pints) can be recognized.



## Offline programming

With this CAD conversion, assembly and dispense data as well as the whole libraries can be edited at a separate workstation. The processed data can be transmitted to the Pick&Place machine afterwards.



# Software modules

## PAsmartBULK

This module offers an automatic search for bulk goods components and the integrated component turning station even fully automatically turns parts that are the wrong way up.

The automatic component search alleviates and accelerates the production of the smallest series and prototypes considerably. The software automatically scans with the head camera for the required components prior to each assembly. In doing so, it even takes into consideration the component size in case a wrong component happens to be in the tray.



## PALoose Components

The placeALL® range offers by standard a procedure for manual picking of single components to create the assembling of loose components effective and safe. The machine isn't only able to pick single components from a feeder. It features also the possibility to mark any components before starting the assembling. This enables the user to begin an automatic assembling after designing.

The optional smartBULK feature recognizes automatically the loose components in the container. This quickens the assembling significant.

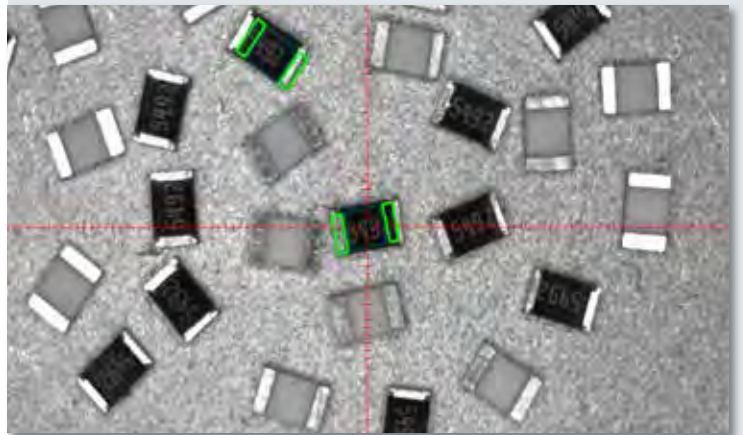

## PA barcode label

With this module it is possible to print out your own barcodes for managing components. Together with the barcode module, this enables quick, easy and safe setup. The barcodes to be printed out can be customized using a designer.





# Software modules

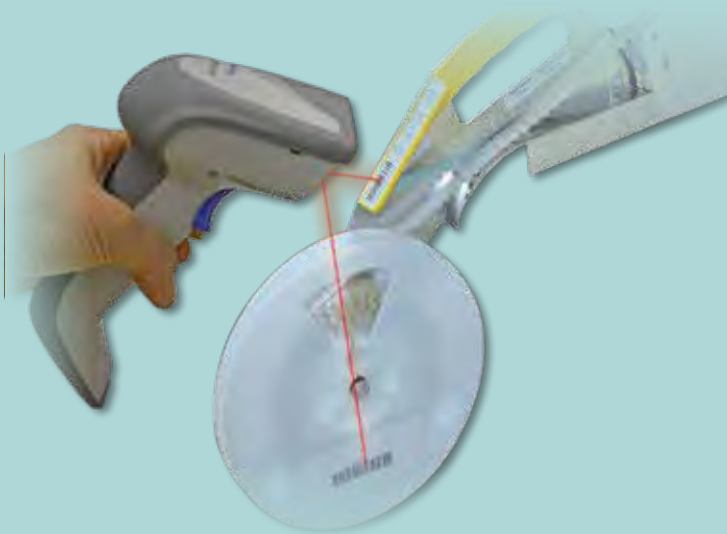

## PABarcode

All **smartFEEDERS** can be set up using a wireless barcode reader. Together with the warehousing module you can read out the current stock. By using the reader for a setup, it is ensured that the correct component is set up on the correct feeder.

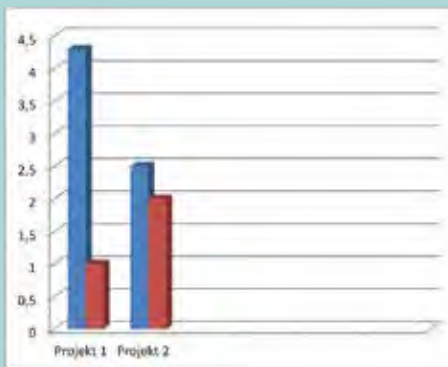

## PAStatistics

To calculate an order, all available data such as assembly time per circuit board is documented and analyzed by this module.

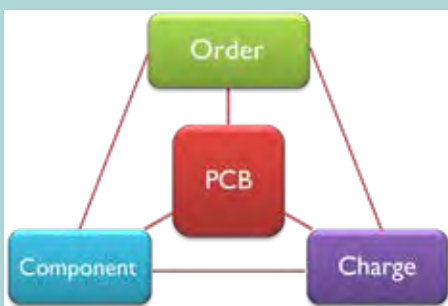

## PATrace

This module documents which component from which lot has been used on which circuit board and with which order. This enables historical production runs to be interrogated, in case of a recall enquiry.

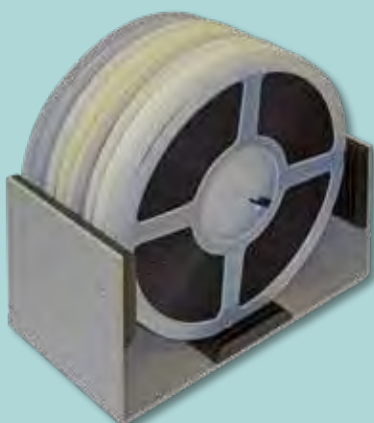

## PAStorage

This module manages all SMD parts, circuit boards and other components used in production (like heat sinks or other standard parts) that you have in stock. The assembled components are debited from the stock automatically as they are used. The user is informed by settable minimum stock levels, whether a stock item has to be reordered.

PAStorage distinguishes between the whole warehouse and the parts currently stored on the machine.



# Software modules

## PANetState

All machine messages are transferred to a separate PC on the network and displayed there. The user is informed i.e. if production is finished and can initiate further steps.



## PALevel

For assembling of MID interconnect device the module „Z-Level“ can be integrated. This module enables the placing of components on different levels - on higher and deeper levels. So the module is useful for placing components on interconnect device like for example Embedded Components in PCBs.

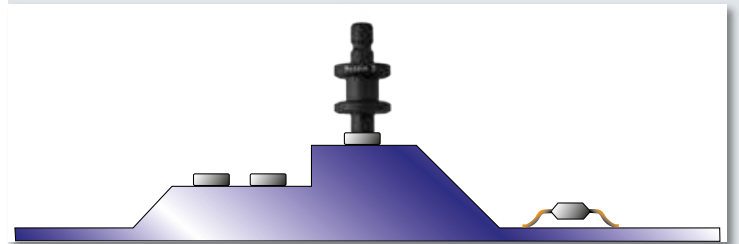

## PA-LEDpairing

The optional software-module PA-LEDpairing has been developed to combine LED to resistor. So the manual assignment isn't longer necessary and errors can be avoided.

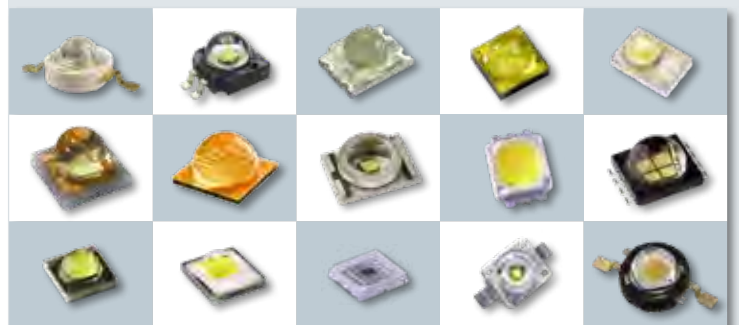

# Feeder systems



Coloured grips for better distinction of the tape width

The **placeALL®** range of fully automatic machines offers the right feeder for every SMD model. The feeder system includes feeders for rolls, sticks, trays and for loose components and is available for all automatic machines.

## smartFEEDER

This is a must, especially with small and medium-sized quantities. Feeder system be flexible and yet absolutely secure in order to guarantee high quality at low costs. All information on the prepared components is saved in the smartFEEDER itself.

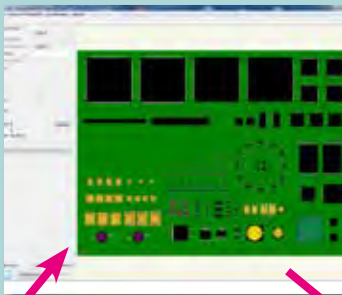

## Automatic recognition

When plugging in a **smartFEEDER**, the feeder is automatically logged in to the system. In this event, not only the data of components are automatically passed on to the feeder but also the picking positions. The system log-in takes only a few milliseconds. Thereby it doesn't matter which feeder slot or to which side of the machine the **smartFEEDER** is plugged into.

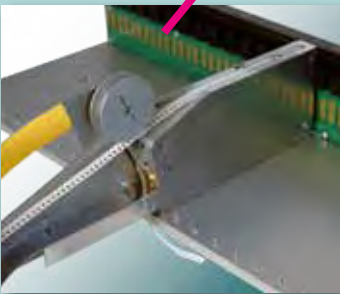

plug-in → log in → assemble  
0ms                      50 ms                      100 ms

The pick & place machine immediately knows the picking position and its feeding program is automatically adapted to the new feeder without intervention of the operator. Empty feeders can thus be replaced during the current feeding.

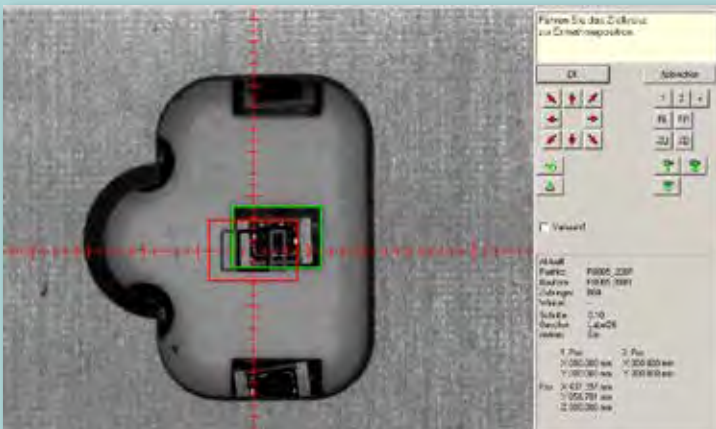

## Automatic pick & place correction

The serial software module automatic pick&place correction (APC) continuously monitors the picking position from the feeders. In the event that the picking position is not correctly calibrated or the picking position of a belt changes slightly during assembly, then this module will automatically adjust the picking position and the stability of placement/assembly will be significantly increased. APC applies a statistical procedure for the correction of the picking positions. Therefore, individual outliers do not cause a faulty correction. The APC is part of the software of the fully automatic machine of the **placeALL®-series**.





# Feeder systems

## tapeFEEDER

All tapeFEEDER are smartFEEDER. They have an easily accessible control panel for the manual infeed and outfeed, a status indication with 2 LEDs as well as the series number with barcode, through which the feeder can also be equipped with a barcode scanner. The feeders can pick up rolls up to 8" by default. With extensions 13" rolls can be handled.

### Technical details:

- 8 mm - 72 mm tape width
- for blister- and paper tapes
- direction change tapes  $\varnothing=64\text{mm}$
- microprozessor controlled
- high speed communication
- redundant plug

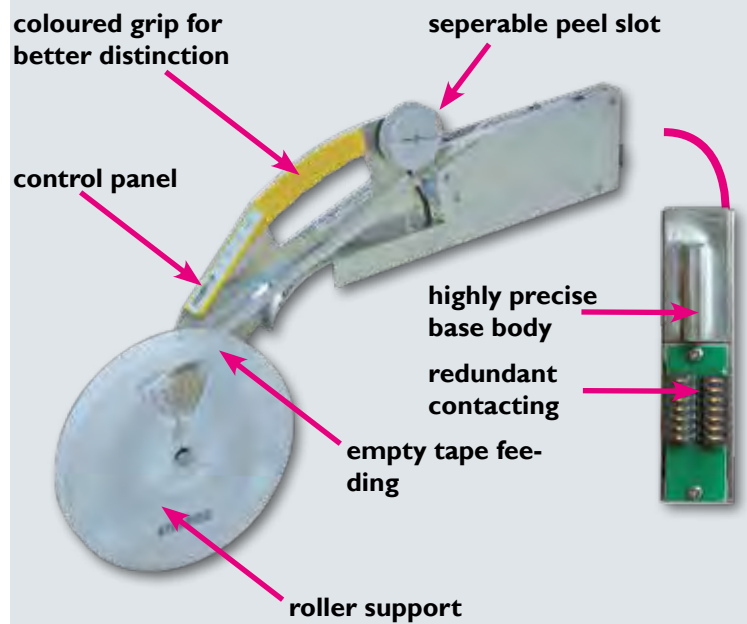

threading



## blockFEEDER

The use of blockFEEDER can facilitate a space saving set-up of the components up to 0603, for example, implement a standard set-up, during which standard components remain always mounted on the machine. Only a few project specific components must be retrofitted.

- Processes 10 x 8 mm tapes with  $\varnothing$  180 mm optional 5 x  $\varnothing$  180 mm and 5 x 330 mm
- max. thickness of the tape 1.1 mm; max. height of the tape 1.6 mm
- Dimension from the tape to the border of the tape min. 1 mm

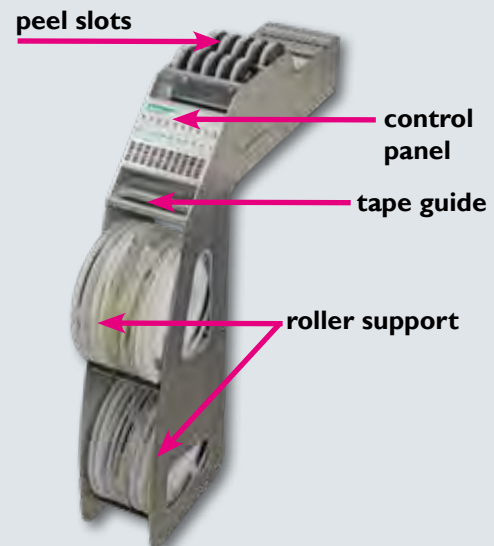

## vibrations tubeFEEDER

Both the amplitude as well as the frequency can be adjusted on the stick feeder. This allows an optimal adjustment of the infeed to the set-up components. The vibration starts automatically by removing the components and stops automatically after a set length of time. This ensures that sufficient components are always available.



# Feeder systems

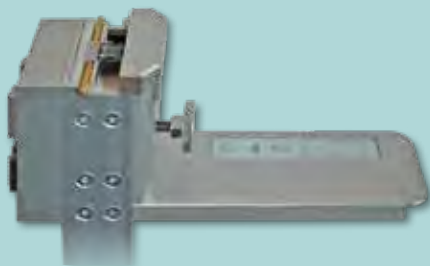
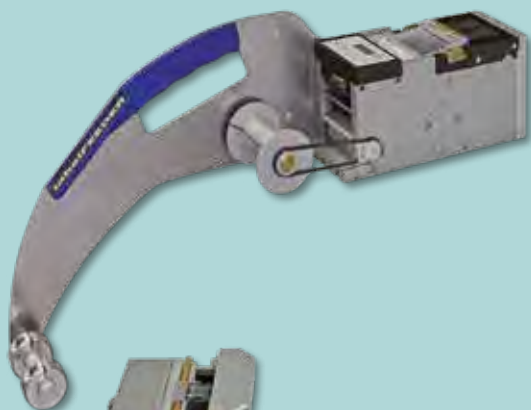

## labelFEEDER

The FRITSCH **labelFEEDER** allows an exact label transport to the picking position of the pick&place machine. A fast setup is guaranteed by the well-arranged four-button control panel and the wide range of label- and tape sizes fitting to the feeder. Together with the compact dimensions of the unit a highly efficient labeling solution was created.

## stick-domeFEEDER

For the production of keypads feeder for the support of domes are available. The feeder are useable for all standardized domes. We can also implement customized solutions.

## ledFEEDER

There are feeders for assembling THT LEDS available for all machines of the **placeALL®** series. These feeders feed the LEDs from standard reels, cut the wires and place the LEDs in the right position for assembly. The length of the wires can be adjusted with corresponding adapters to any size.

FEEDERtype	Order number	Slots	Tape width	Tape depth*	Rack-Position	Notes
tapeFEEDER	908.121.008	1	8 mm	6 mm	all	half step for 0402/0201
tapeFEEDER	908.120.008	1	8 mm	6 mm	all	
tapeFEEDER	908.120.012	1	12 mm	6 mm	all	
tapeFEEDER	908.120.013	2	12mm	13 mm	all	
tapeFEEDER	908.120.016	2	16 mm	13 mm	all	
tapeFEEDER	908.120.024	2	24 mm	13 mm	all	
tapeFEEDER	908.120.032	3	32 mm	13 mm	all	
tapeFEEDER	908.120.044	3	44 mm	13 mm	all	
tapeFEEDER	908.120.056	4	56 mm	13 mm	all	
tapeFEEDER	908.120.072	4	72 mm	13 mm	all	
blockFEEDER	908.160.008	5	8 mm	3 mm	all	for 10×8 mm-tape
tubeFEEDER	908.121.002	5	-	-	all	for 10×SO08
trayFEEDER	908.170.410	13	-	-	machine-specific	for 8 x JEDEC Tray

\* Please take note of the bending radius.



# Feeder systems

## trayFEEDER

- up to 8 JEDEC-Trays
- automatic supply of the right component while assembling
- integration in the operating interface
- retrofit at existing machines
- integrated controller of axis for gentle motion of the high-value components

## Tray holder

Multiple tray holder per one JEDEC tray can be used inside the placement area. Thus the placement area of the Pick & Place machine can be adapted easily to different projects and tasks.

## Tray for loose components

The loose-component feeder for the placeALL® includes 36 pickup positions. Every tray has a clear cover, to keep the components shield and clean from dust.

## IC FEEDER

25 different ICs can be equipped on the IC feeder. Therefore it has inserts with three different widths for different applicable components. These inserts can be adjusted on custom-made projects.

## Universal tapestripFEEDER

The universal tapestripFEEDER for tape strips or whole rolls can be mounted in addition to our smartFEEDER around the machine. Therefore the user has more inner space for PCBs or trays.

## Tape-strip feeder

When assembling prototype runs, tape-strips are often used. With this feeder, up to eleven 8 mm strips (or fewer, but wider strips) can be fed simultaneously.

## Holder for high component tapes

The Universal-Tape-Strip-Holder is suitable for component tapes up to 27 mm height. Built for the use of tapes with a width from 8 to 56 mm.

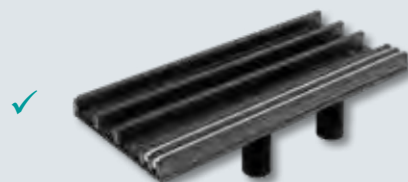
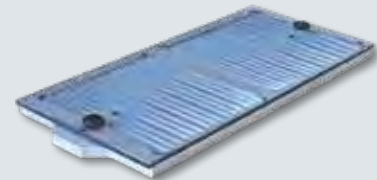
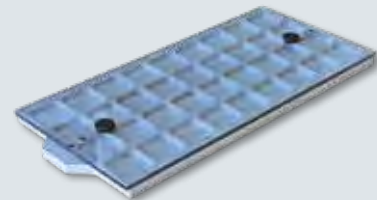

✓ All these feeders can be placed in the assembling area by magnetic bases.



# Feeder systems

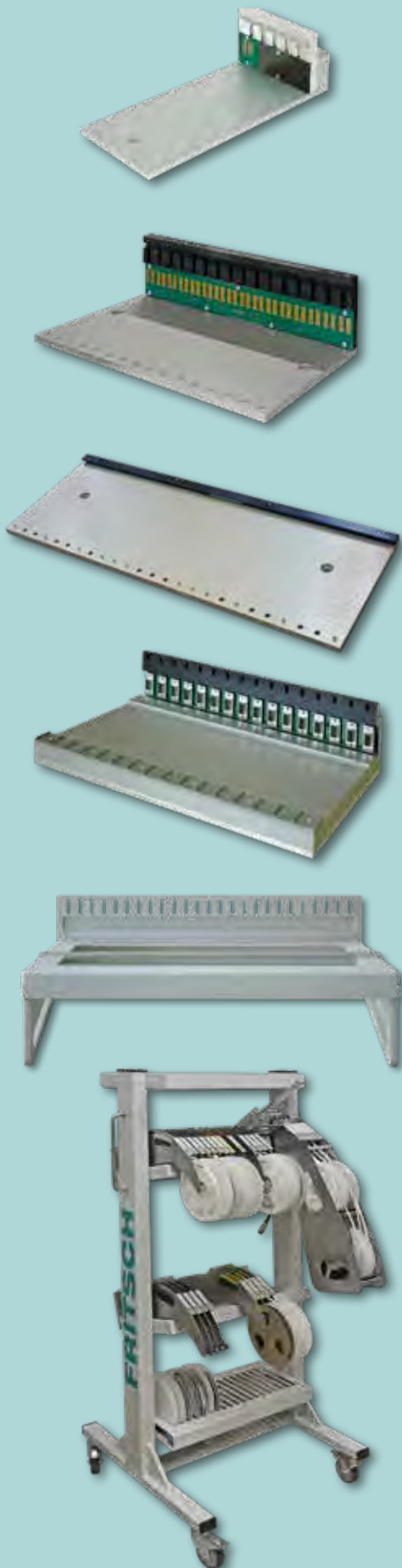

## Feeder set-up stations

An external feeder set-up station enables a set-up of feeders irrespective of the machine. Thereby the set-up of a new project can be carried out at the same time as the current project is still being assembled.

## Feederracks

Feederracks are required to use tape or tube feeders on the machine. Each rack ensures the communication to the individual feeders. Depending on the type of machine, different feederracks can be mounted.

## Rack for universal tapestripFEEDER

This rack guarantees the save intake of universal tapestripFEEDER.

## Feederadapter

The feederadapter allows the use of belt and bar feeders using a sub-D connection on present machines. The adapter allows the set-up of the feeders in the software and thereby emulates the additional functions on present machines.

## Table feeder storage

Portable or at the working place mountable feeder compartments enable the solid and vertical storage of feeder which are not in use at the machine.

## Feeder storage rack

The feeder trolley makes it possible to safely store all feeder units that are not required for the current assembly process near to the placement machine. Whilst the machine is producing, the operator can already get the feeders needed for the next project on the feeder trolley.

The feeder trolley has the following racks:

- 2 x racks with 25 slots for feeders
- 1 x rack for small parts



# Conveyor systems

## Fast and easy

The standstill and changeover times must be reduced, especially for small series. The different conveyor systems have been optimized precisely for this. Both the setting of the PCB width and the positioning of support pins below the circuit board are done without tools. Depending on the application and local conditions, the optimal conveyor for PCB transport can be selected:

- motorized width adjustment
- Flat belt
- 3 zone conveyor
- one-sided batch conveyor from left or right

## Customization

By request the conveyor can be equipped with a customized intake for workholding fixture. This enables to handle even heavy or customized workholding fixture in the placeALL®.

## Stressless motion

To bring sensitive PCBs such as ceramic substrates or partial assembled PCBs safely to the placement position, the PCBs are slowly moved through a ramp of deceleration to the stopper and so the mechanical load is reduced to a minimum. All conveyors are fully programmable. The rate of feed, ramps and waiting times can be adapted to the application.

## SMEMA Interface

Each conveyor has the standard SMEMA interface. Thus, machines can easily be integrated into any production lines or even combined with a loader and unloader to automate partial the pick & place process.

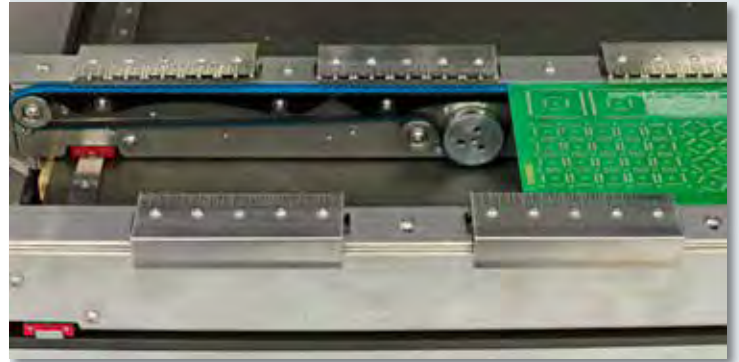

Standalone

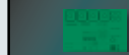

Batch-System



Inline-System



# Dispensing systems

Dispensing valves	PA520	PA620/L	PA610XL
Time-pressure	✓	✓	✓
Precision	✓	✓	✓
Jet-Dispensing-System		✓	✓

## Dispensing module

When producing prototypes and small series, it is advantageous to apply glue or solder paste on the PCBs with a machine and then to assemble the components. Several dispensing systems are available and with the double dispenser module it is possible to handle two various fluids.

## Time-pressure dispenser valve

The simple design of attaching the valve makes it particularly robust and low-maintenance. The adjustable pressure affects the cartridge after a short period. The desired amount can easily be set in the software. Normally for solder paste or glue for rough structures.

## Precision dispenser valve

In the case of the precision dispenser valve, additional parameters such as temperature and the fill level of the cartridge are collected. The processor control regulates these values, the pressure and the time of the dispensing impulse in order to achieve the highest repeat accuracy. This enables the safe dispensing of amounts from 0.001 to 10 mm<sup>3</sup>. By this Fine-Pitch components down to a pitch of 0.5 mm can be safely dispensed.

## Jet-Dispensing-System

Jet valves from various well-known manufacturers can be defined and integrated depending on the application. The high dispensing frequency makes it possible to apply both the smallest and larger quantities with just one dispensing head.

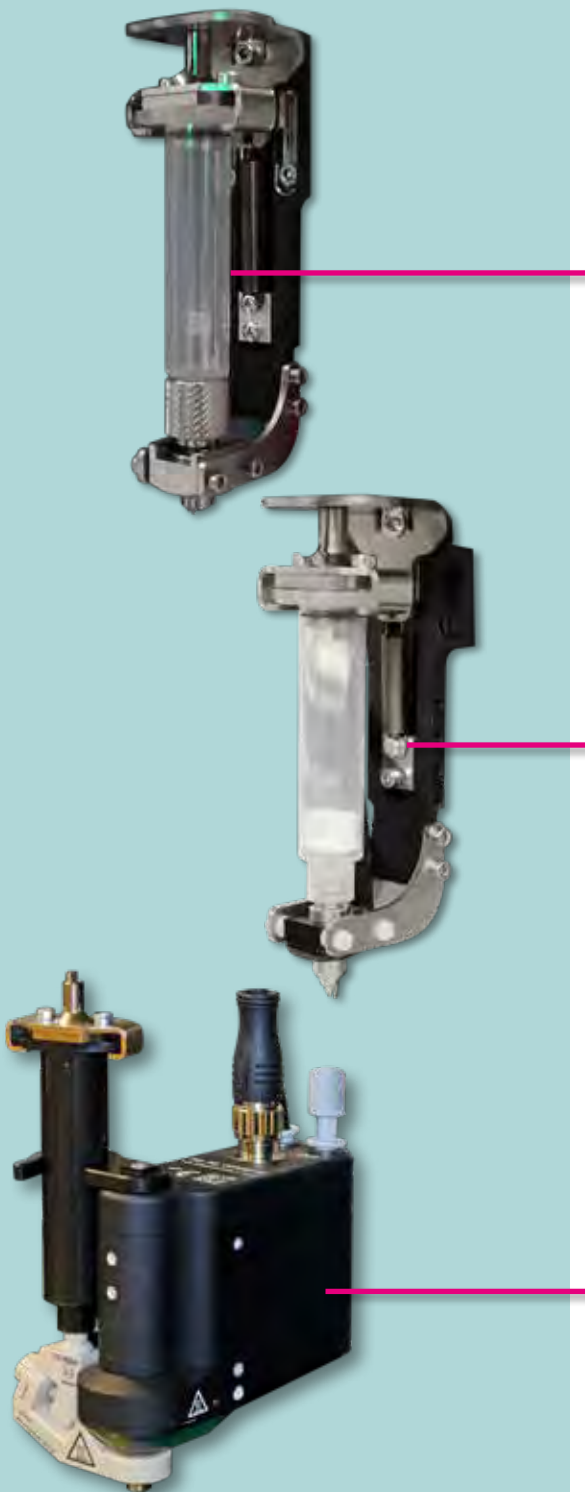





## PCB intake

The universal PCB quick-device allows easy fixing of single or double-sided PCBs with different shapes. Therefore are various fixed magnetic recordings.

- PCBs up to 910 x 760 mm
- Clearance under the PCB 32 mm
- Clearance above the PCB 15 mm
- Single- and double-sided PCBs
- No tools for adjustment
- Free positioning of PCB support with a magnetic
- Components up to a height of 20 mm possible to place



## Vacuum table

For assembling of flexible PCBs a vacuum table can be integrated. There are variants for a complete vacuum suction of PCBs as well as for a partial vacuum suction. The attachment of the vacuum table is possible without the use of tools. A changing from vacuum table to the conventional PCB intake happens with the help of the grips just in a few moments.



## Auto-Blow-Option

To ensure the replacement of flexible PCBs, blow-off-option can be integrated. This device will be activated just before the extension of the PCB carrier and brings a minimum air film between the substrate and vacuum table for a clean separation and to ensure safe transport of the PCB.

## Assembling tools

As standard, the placeALL® has six different tools per placement head. Five are spring-loaded, so that smaller differences in the placement height can be compensated for. The tools can be easily dismantled for cleaning purposes.

The FRITSCH company offers a large tool portfolio for the fully automatic placement systems. Customer-specific tools are also manufactured. Please feel free asking us!



# Accessories

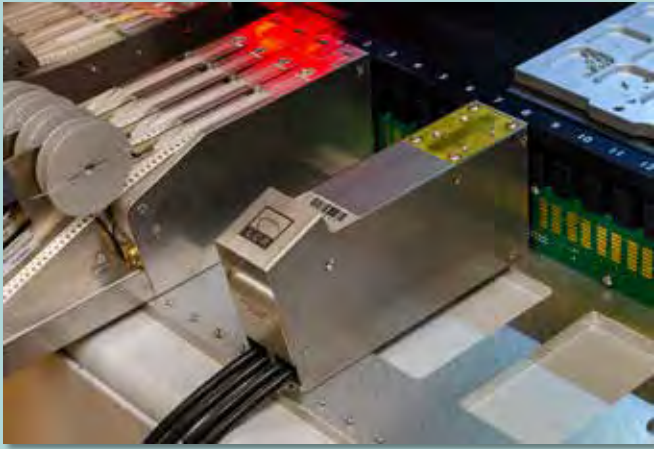

## Test station for components

The need to document the exact value of a component is omnipresent. Whether it is a 100% control in the case of high grade mounting functions such as in the field of medicine and in the field of astronautics or also the tracing of a newly opened batch of components. The need to document the value of components is given. And a test station makes sense for particularly this purpose.

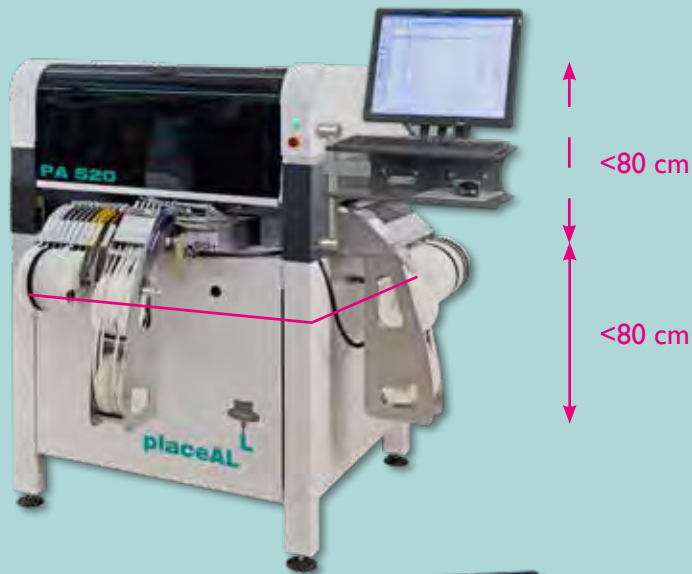

## Dividable machine frame

To pass through door frames with less than 80 cm in width, the **placeALL**®520 and **placeALL**®620/620L machine frames can be built dividable, each part being smaller than 80 cm.

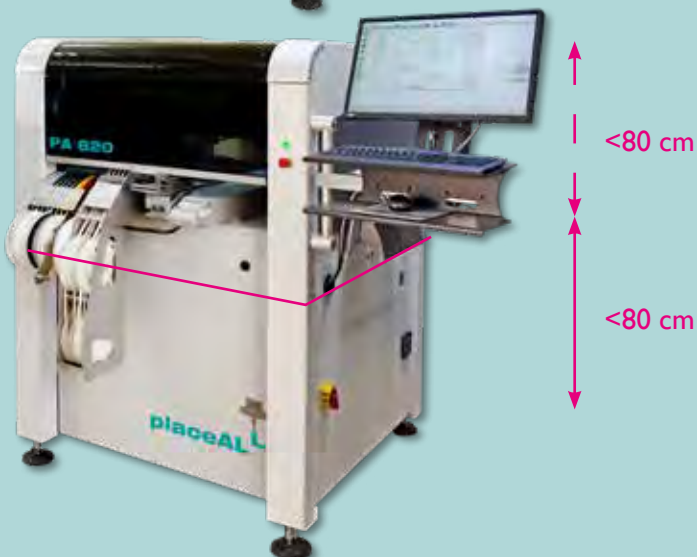



## Large components

Although the size of constructions in the electronics industry has been further minimised for many years, there are still sufficient fields of application where a miniaturization is not possible. In order to automate the assembling of such constructions, a machine is required that excels with both component dimensions and with its flexibility.



## Flexible PCBs

Whether it's a flexboard only or a Starrflex PCB, both provide enormous potential for optimising costs or they offer a compromise between a rigid PCB and a 3D MID component. Flexible PCBs are easier to integrate into the existing mechanical environment and thus create a new way of implementing your developments. Typical applications of these boards can be found in the automotive industry or robot technology.

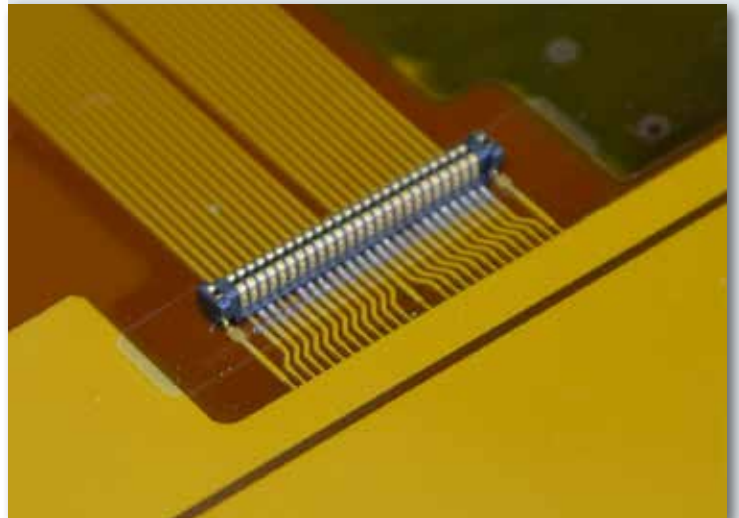

## Production of membrane keyboards

The manufacturing of membrane keyboards or displays is still mainly manual production of the components. FRITSCH provides some unbeatable options for cost optimization and acceleration of production with their pick & place machines for the assembly of domes and LEDs.

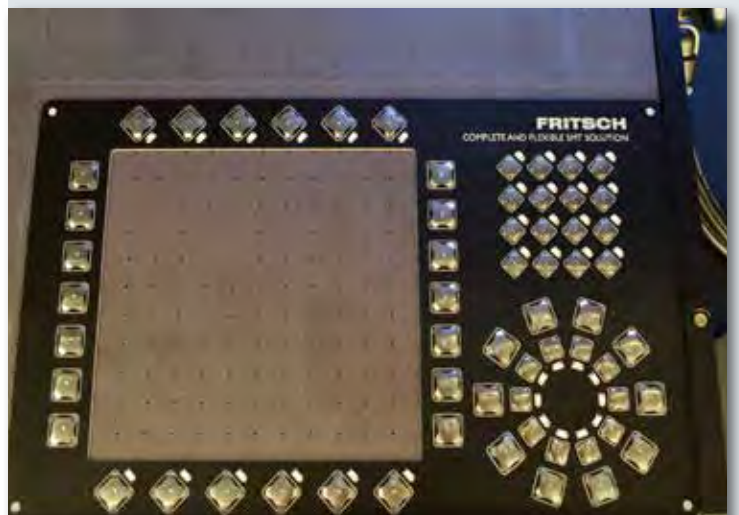



# Applications

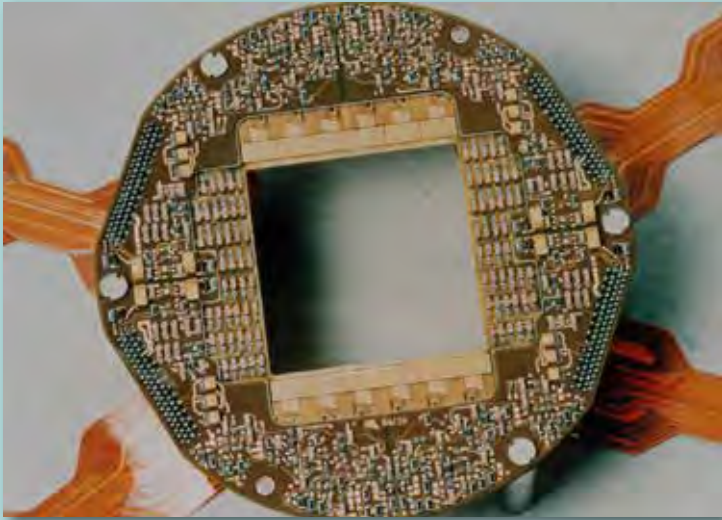

## Aerospace

The electronics production in aerospace pursues entirely different goals than conventional electronics assembly. For more than 20 years now, FRITSCH has been developing special pick & place machines for this sector in close cooperation with the respective companies and institutions.

Back then, it all started with semi-automatic assembly stations with integrated component testers for measuring the component values – immediately before assembly. This was the only way the extreme demands of traceability and product quality could be ensured.



## Power electronics

Electric power systems in the automobile sector, industry or many others fields of application require optimised motor electronics for their efficient functionality. When producing power electronics, other materials than for normal electronics production are used.

Thicker layers of copper for higher currents, aluminium or ceramic as carrier material require specially adapted production equipment.



## Odd shape assembly

The pick & place machine has a vision system which can recognize and align any shape in the easiest way. Therefore even irregular components such as inductors, switches or similar can be assembled in place.

Due to the component height that can be processed of up to 20 mm, the placeALL pick & place machine also enables the production of dissipators, shields or other mechanical components. Thanks to the adjustable pressure when assembling such components, mechanical alignment pins can be printed into the PCB.



# Special solutions

## Customized adjustments

Our flexible and standardized machines allow cost-effective adjustments to a wide variety of tasks. This illustration shows an extendable assembly table that is already used in our stencil printers.



## Customized feeders

Since we have the entire development, construction and production in-house, we also solve tasks you have set for which the standard feed units cannot be used. If you have any questions, please feel free to contact us.



# Special solutions



## anyFEEDER

This custom made makes it possible to feed any components. Their made-to-measure production shows impressively how customer requests are realized by Fritsch GmbH.



## Integrable portal

The module consists of a portal with X,Y,Z and R axes with an integrated vacuum suction device for the pick & place of the components. For the centering of components, laser or vision centering can optionally be integrated directly on the pick & place head. There is also the option of integrating stationary vision systems for various recognition and correction tasks.



## Creative applications

In order to offer those interested in the stand something at trade fairs, we have taught our fully automatic machines to play checkers and keyboards, among other things. In addition to the maintenance, this should make it clear how versatile our machines can be. No matter how unusual our customer requirements are, our developers find solutions for placement tools, feeders, programming, etc.



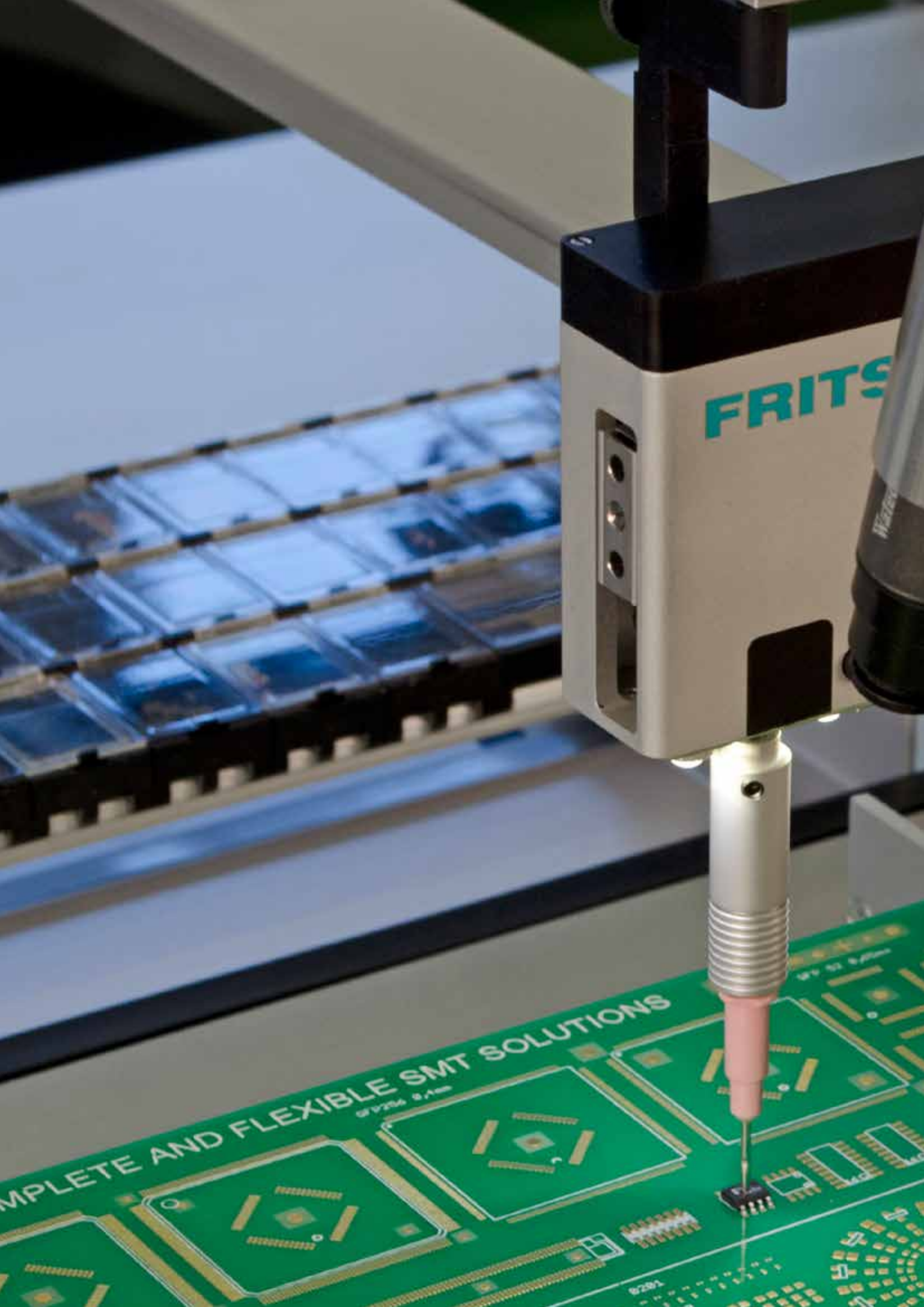

FRITSCO

COMPLETE AND FLEXIBLE SMT SOLUTIONS

# classic

The successful Manipulator range from FRITSCH is excellent qualified for the production of high-grade prototypes and small series in electronics. For research and development in universities and for starter in SMT production it is the right choose.

A lot of options like for example cameras, axis-locking or a dispensing system support the user by daily work.

The modular constructed manual and semi-automatic assembling systems realize the whole process from dispensing of solder paste or glue up to pick & place the different chips, SO and FP components etc. The semi-automatic systems release the user from reading project or placing lists. It shows the pickup and place positions and controls the processes. By this, a 100% assembling-safety is guaranteed. The intelligent software and a CAD-DATA converter enable a fast and error-free process

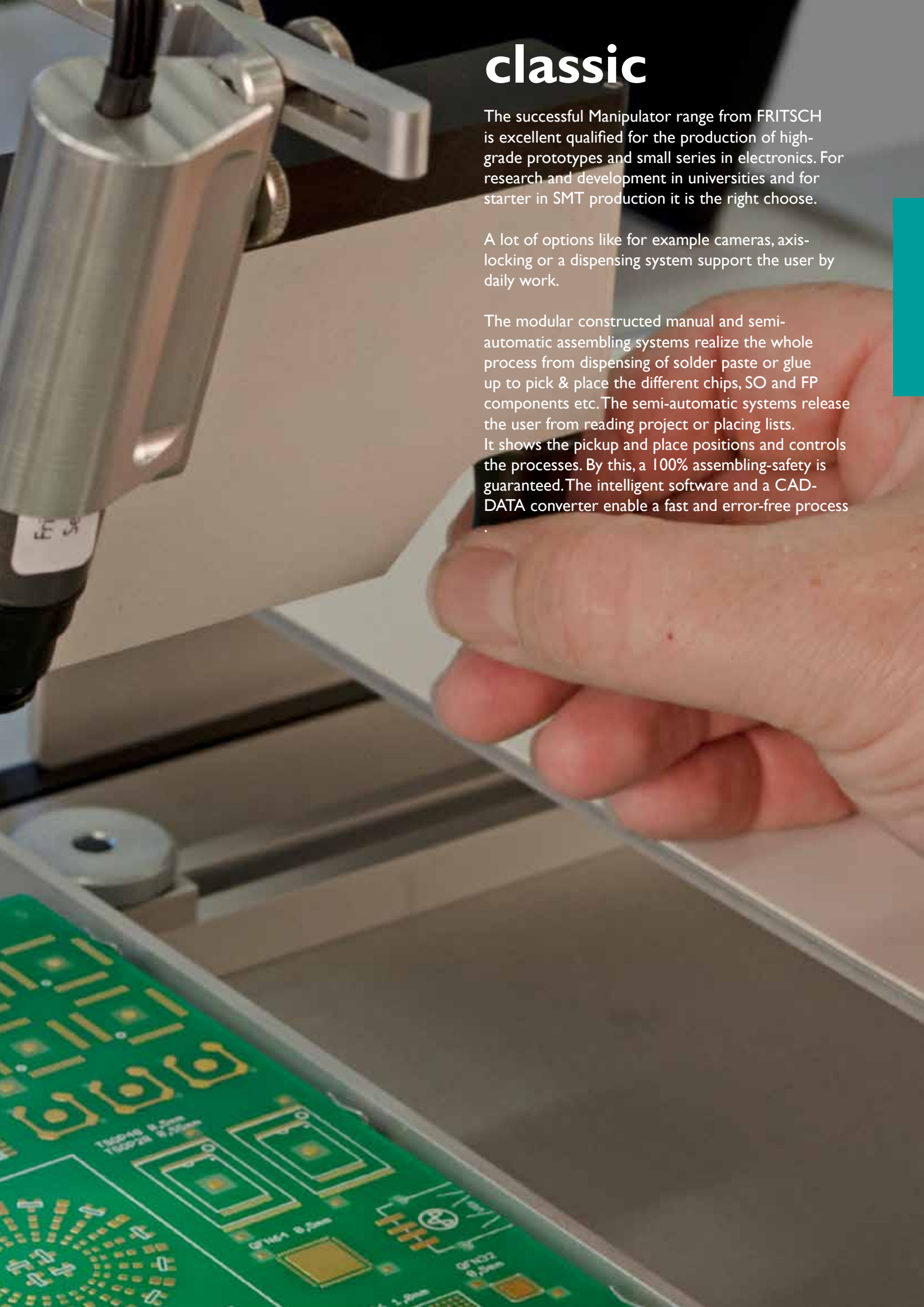





The **LM900** is the smallest of the range for the cost-efficient entry. The **LM900** owns all basics of a pick and place system but waives to a control unit and more options. A vacuum pump activates automatically the nozzle to pick the components. While placing the vacuum is mechanical interrupted. By means of a spring in the assembling head it is pushed up and the vacuum activated again.

## Simple Operation

The **LM900** was designed for manual PCB processing. Special care was taken to ensure that the operator can concentrate on the essentials. This increases productivity many times over.

## Unbeatable cost-performance ratio

The **LM900** has all the essential features of a placement area, with the holder for holding a 5/10 cm<sup>3</sup> syringe it can also be used for dispensing by means of an external control (not included in the scope of delivery).

## Ergonomic

Even the smallest of the Pick & Place Machines is equipped with the renown light FRITTSCH guides which makes it easy to place SMDs accurately.

The controls are arranged ergonomically. The **LM900** thus not only looks after your PCBs but also your staff.

## Flexibility of Feeder System

All LM900s are equipped with the FRITTSCH Rail System. A wide range of feeders can be fixed quickly and replaced as complete sets or kits. The whole range of SMDs can be handled: Mini and Micro Melfs, SO, PLCC, Fine Pitch Devices and Chips.





# LM900

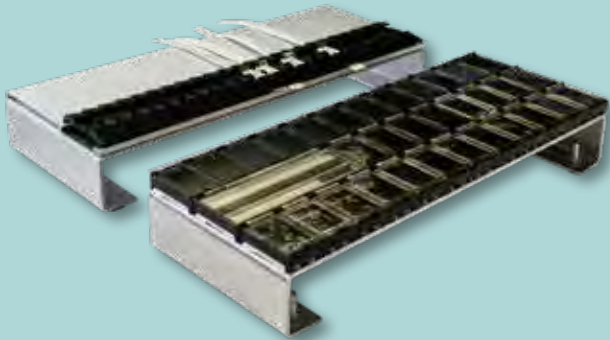
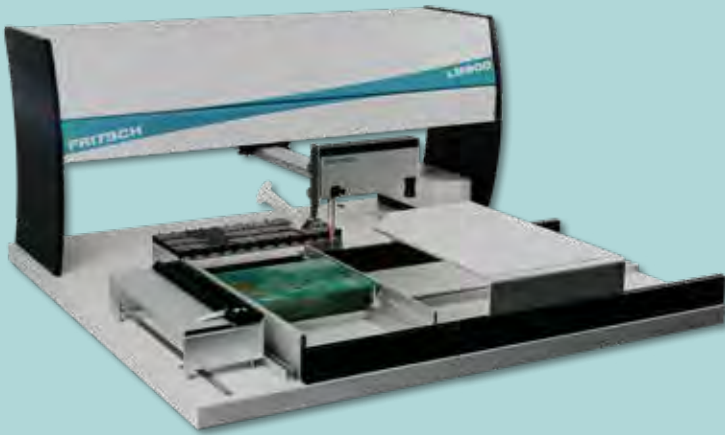

## LM900.110

Manipulator for assembly work including an external vacuum pump.

With holder for a 5/10 cm<sup>3</sup> syringe for dispensing by external control (not included).

1 x support with 36 small SMD containers with clear lid  
1 x Tape Strip Support with Rail Unit and with 24 Mini feeders

## Technical details

Placement rate is from experience 300 - 600 SMDs/hour.

max. PCB size: 550 mm x 310 mm

max. placement area: 425 mm x 310 mm



The **LM901** is the entry model of our modular-built systems. Besides the **LM900** functionality, it can be extended with axis brakes, dispensers and optical support systems for component placing. The system supports the whole dispensing-/ Pick & Place - process, from supplying the solder paste or glue to placing standard, Fine-Pitch or BGA components.

## Ergonomic

The unrivalled smooth-running guide of the mounting head helps to place the SMDs accurately. When the pipette comes into contact with the components, the vacuum automatically switches itself on and when placing them, it switches off. The adjustable vacuum reactivation alleviates and accelerates the extraction of components, especially from bulk goods containers and when mounting Melfs.

## Integrated dispensing unit

There is a dispenser system available to integrate into all manipulators. Besides soldering paste and adhesive, other media can also be dispensed.

The dispenser system automatically switch on the dispensing process as soon as the slanted dispenser needle comes into contact with the PCB. The vertical syringe ensures that the dispenser needle does not slip sideways when touching the PCB.

Three programmable dispensing times are available for the dispensing on different pad sizes. They can be preset in the menu as required.



# LM901



## LM901.110

Pick & place machine

Scope of delivery:

LED-lighting  
various nozzles

## LM901.111

Pick & place machine with dispensing unit

Scope of delivery:

LED-lighting  
various nozzles  
dispensing unit  
syringe adapter 5 cc  
syringe solder paste  
various dispensing nozzles

## LM901.112

Pick & place machine with dispensing unit and X/Y-locking

Scope of delivery:

LED-lighting  
X/Y-locking  
various nozzles  
dispensing unit  
syringe adapter 5 cc  
syringe solder paste  
various dispensing nozzles

## Technical details

Placement rate is from experience 300 - 600 SMDs/hour.

max. PCB size: 550 mm x 310 mm

max. placement area: 425 mm x 310 mm

## LM901.211

Pick & place machine with dispensing unit  
(+ 200 mm in X- and Y-axis)

Scope of delivery:

LED-lighting  
various nozzles  
dispensing unit  
syringe adapter 5 cc  
syringe solder paste  
various dispensing nozzles





The **LMinline** is the intelligent combination of the proven **LM901** manipulator and the inspection conveyor. This combination, used in the operation of **placeALL® smartLINE**, allows to do manual pre-or rework at PCBs. As a standalone version circuit boards can be easily dispensed and placed. The PCB moves automatically through motor driven belts in the assembly area of the **LM**. By pressing a button, the finished product can be fed to the next step. Using simple width adjustment size of board can be adjusted easily.

## Flexibility of the component feeders

Various feeders can be installed and exchanged fast – even as complete sets. This means the whole range of SMD shapes can be processed:

Chips, Melfs, SO-, PLCC- and QFP components etc.

It is only possible to use feeders from backside.



# LMinline

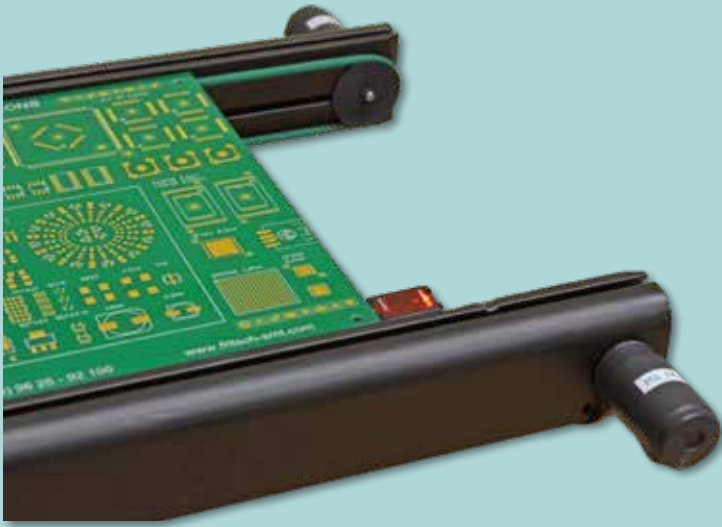

## LMinline I 10

Manipulator with conveyor for pick & place work

Scope of delivery:

LED-lighting  
various nozzles

## LMinline I 11

Manipulator with conveyor for dispensing and pick & place work

Scope of delivery:

LED-lighting  
various nozzles  
dispensing unit  
syringe adapter 5 cc  
syringe solder paste  
various dispensing nozzles

## LMinline I 12

Manipulator with conveyor with X/Ylocking for dispensing and pick & place work

Scope of delivery:

LED-lighting  
X/Y-locking  
various nozzles  
dispensing unit  
syringe adapter 5 cc  
syringe solder paste  
various dispensing nozzles

## LMinline I 40

Manipulator with conveyor for dispensing work

Scope of delivery:

LED-lighting  
dispensing unit  
syringe adapter 5 cc  
syringe solder paste  
various dispensing nozzles

## Technical details

Placement rate is from experience 300 - 600 SMDs/hour.

max. PCB size: 800 mm x 300 mm

max. placement area: 530 mm x 300 mm





# LMdispense

The **LMdispense** is a simple FRITSCH dispensing machine and can be used in any situation: from laboratory use to production. There is the time-pressure system available for all manipulators. Besides soldering paste and adhesive, other media can also be dispensed.

The dispenser system automatically switches on the dispensing process as soon as the slightly slanted dispenser needle comes into contact with the PCB. The vertical syringe ensures that the dispenser needle does not slip sideways when touching the PCB.

There are nine different times for dispensing available for dispensing on different sizes of pads, which can be selected directly in the dispenser menu. The individual times can be preset as required. In addition, the operator can apply in a simple way lines for the adhesion of mechanical components or underfill with the line dispenser module. The line dispenser is controlled by a foot switch.





# LMdispense



## LMdispense

Manipulator for dispensing work

Scope of delivery:

LED-lighting  
dispensing unit  
syringe adapter 5 cc  
syringe solder paste  
dispensing nozzles set



## Technical details

Dispensing rate is from experience 300 - 600 dots/hour.

max. PCB size: 550 mm x 310 mm

max. dispensing area: 380 mm x 310 mm



The **SM902** closes the gap between the **LM901** and the semi-automatic machine **SM902professional**. Integrated measuring system eliminates wrong placements and relieves the user. Required information like pick-position, place-position and rotation angle of the component are displayed on the monitor. Therefore the extensively searching on plans isn't necessary. From the beginning the user is guided systematic through the whole project. The same options are available for the **SM902**-systems like for the **LM901**-systems. To further support the user, the **SM902** can be upgraded step by step to the functionality of the **SM902professional** with LEDdisplay, automatic feeders and an automatically driving eye.

## Software

The sophisticated software enables a smooth and fast flow. Already while teaching in the PCB the system shows its power. In a few moments the single positions can be programmed. While teaching in the first PCB can be assembled. This improves the efficiency and a control just in time. The simple handling of the system-software makes a fast and safe programming while assembling possible: Choose a PCB, place the reference points and production starts.

## Fast Pick & Place

The simplicity of the assembling process encreases the performance: The user can be concentrated exclusively on the pick & place. Scanning the plan is omitted completely. Comparing to the manipulator the double or triple quantity is reached. The system software allows additional the optimizing of the assembling process - not only for single PCBs but also for repeat factor.



# SM902

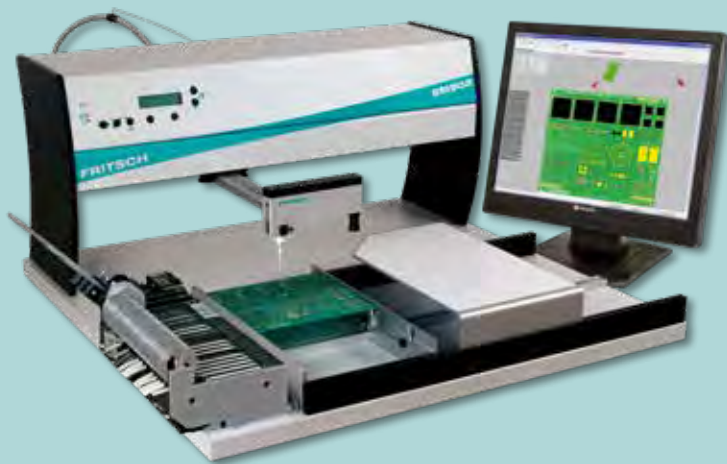

## SM902.110

Semi-automatic manipulator for PC controlled pick & place

Scope of delivery:

Software  
LED-lighting  
various nozzles



## SM902.111

Semi-automatic manipulator for PC controlled pick & place and manual dispensing

Scope of delivery:

Software  
LED-lighting  
various nozzles  
dispensing unit  
syringe adapter 5 cc  
syringe solder paste  
various dispensing nozzles

## Technical details

Placement rate is from experience 400 - 700 SMDs/hour.

max. PCB size: 550 mm x 310 mm

max. pick & place area: 425 mm x 310 mm





# SM902professional

The **SM902professional** offers - besides 100% placement security and a great deal of comfort for the user - a higher assembly output. As by the **SM902** required components are offered by motor-driven feeders. Every feeder shows with the dedicated LED the component which has to be picked. All needed information are displayed in the placement area and a changing view between monitor and PCB isn't necessary. For defining position coordinates, CAD data can be directly imported or the positions can be taught in manually.

## Motor-driven Eye

The motor-driven eye shows the user the exact pick & place position. While assembling the mechanism always drives to the next position. The user has only to insert the stift into the eye and the component is at the right position. The direction-LEDs display just at that moment the polarity of the component on the PCB. The permanent control of all operating elements and the cooperation with the motor-driven eye results a pick & place safety of 100%.



## Picking-LEDs

A separate LED for every feeder enables the fast and error-free picking of components.



## Direction-LEDs

The LEDs on the pick & place head show the hand rotation direction of polarized components. In addition an acoustic signal facilitates the exact placing and the speed of working.



(Monitor and PC not included.)

# SM902professional

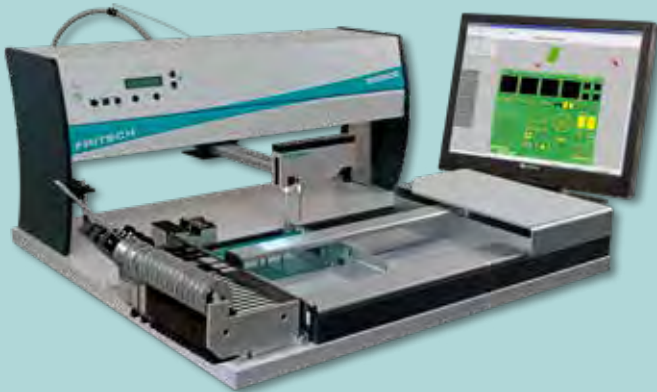

## SM902.210

Semi-automatic manipulator **professional** for PC controlled pick & place

Scope of delivery:

Software  
LED-lighting  
various nozzles

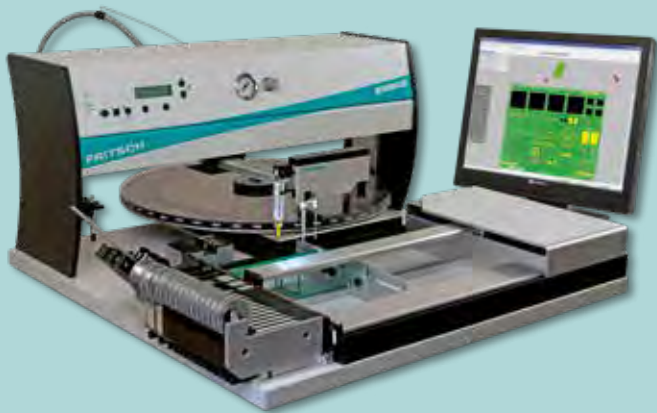

## SM902.211

Semi-automatic manipulator professional for PC controlled pick & place and manual dispensing

Scope of delivery:

Software  
LED-lighting  
various nozzles  
dispensing unit  
syringe adapter 5 cc  
syringe solder paste  
various dispensing nozzles

## Technical details

Placement rate is from experience 500 - 800 SMDs/hour.

max. PCB size: 390 mm x 310 mm

max. placement area: 375 mm x 235 mm

## SM902.221

Semi-automatic manipulator **professional** XL (+ 200 mm in X/Y axis) for PC controlled pick & place and manual dispensing

Scope of delivery:

Software  
LED-lighting  
various nozzles  
dispensing unit  
syringe adapter 5 cc  
syringe solder paste  
various dispensing nozzles

## Technical details

Placement rate is from experience 500 - 800 SMDs/hour.

max. PCB size: 590 mm x 510 mm

max. placement area: 575 mm x 435 mm

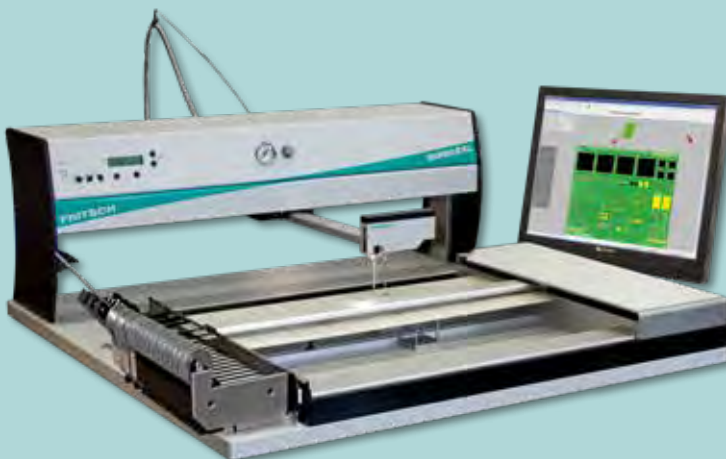



# Multi Placer MP904

The universal assembly station **MP904** combines an easy and flexible handling, together with highest precision by pick & place of Fine-Pitch. The unrivalled smooth-running guide of the mounting head helps to place the SMDs accurately. When the nozzle comes into contact with the components, the vacuum automatically switches itself on and when placing them, it switches off. The special vision system helps optimally to place BGA and QFN components. The component range is from Chip 0201 up to Fine-Pitch and BGA.

## Fine Pitch and BGA placement

The solid construction of the Handling Head insures a highly precise placement of BGA, QFN and Fine Pitch Components. The vision system allows two pictures to be viewed simultaneously. The PCB and the bottom side of the component can be observed at the same time. With the help of a fine adjusting table with micrometer screws, both exposures can be adjusted exactly congruent. An easy and accurate placement of the components is assured. The same options are available for the **MP904** like for the **LM901**. The system is available as pure manual system or as semi-automatic machine.





# Multi Placer MP904



## MP904.410

Multi Placer for pick & place

Scope of delivery:

LED-lighting  
various nozzles  
universal nozzle

## MP904.41 I

Multi Placer for pick & place and dispensing

Scope of delivery:

LED-lighting  
various nozzles  
dispensing unit  
syringe adapter 5 cc  
syringe solder paste  
various dispensing nozzles

## MP904.420

Semi-automatic Multi Placer for pick & place

Scope of delivery:

Software  
LED-lighting  
various nozzles  
universal nozzle

## MP904.42 I

Semi-automatic Multi Placer for pick & place and dispensing

Scope of delivery:

Software  
LED-lighting  
various nozzles  
universal nozzle  
dispensing unit  
syringe adapter 5 cc  
syringe solder paste  
various dispensing nozzles



## Technical details

Placement rate is from experience 300 - 600 SMDs/hour

max. PCB size: 340 mm x 240 mm

max. placement area: 340 mm x 240 mm



# Multi Placer MP904

## MP904.430

Fine Pitch/BGA Placer with X-Y fine-setting table  
(Upgrade with SM/LM possible)

Scope of delivery:

FP/BGA Placer on baseplate  
control box with integrated vacuum pump  
universal nozzle

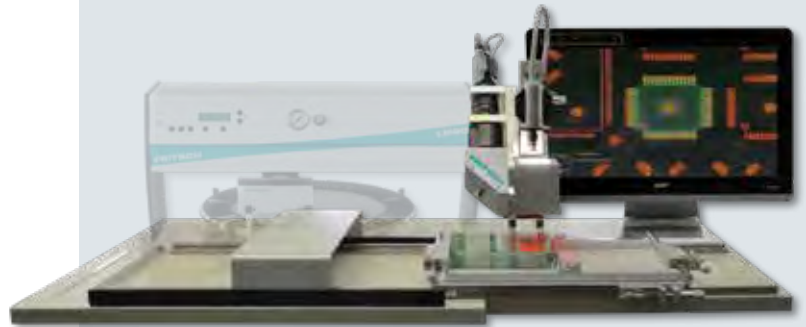

## Technical details

max. PCB size: 340 mm x 240 mm  
max. assembly area: 340 mm x 240 mm

## MP904.43 I

Fine Pitch/BGA Placer with X-Y fine-setting table  
(Upgrade with SM/LM not possible)

Scope of delivery:

FP/BGA Placer on baseplate  
control box with integrated vacuum pump  
universal nozzle



## Technical details

max. PCB size: 340 mm x 240 mm  
max. placement area: 340 mm x 240 mm

# Software

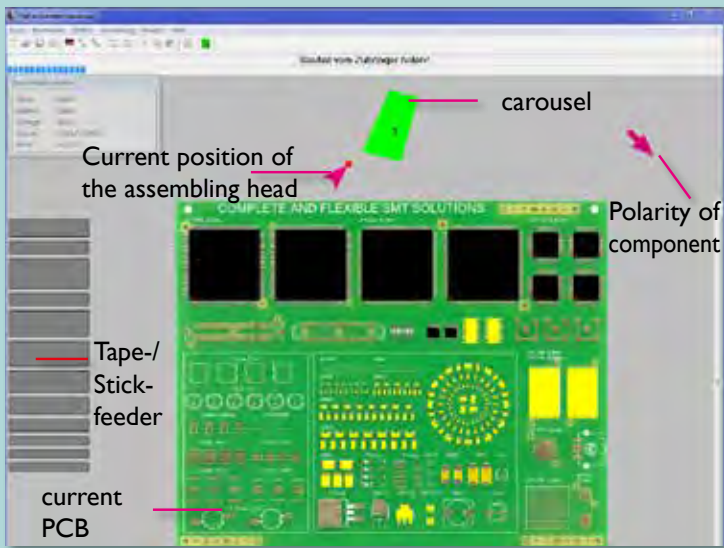

## Software SM902/SM902prof./MP904

The sophisticated software enables a smooth and fast flow. Already while teaching in the PCB the system shows its power. In a few moments the single positions can be programmed. While teaching in the first PCB can be assembled. This improves the efficiency and a control just in time. The simple handling of the system-software makes a fast and safe programming while assembling possible: Choose a PCB, place the reference points and production starts.

LM900	LM901	LMinline	LMdispense	SM902	SM902prof	MP904
				✓	✓	✓

# Softwareoptions

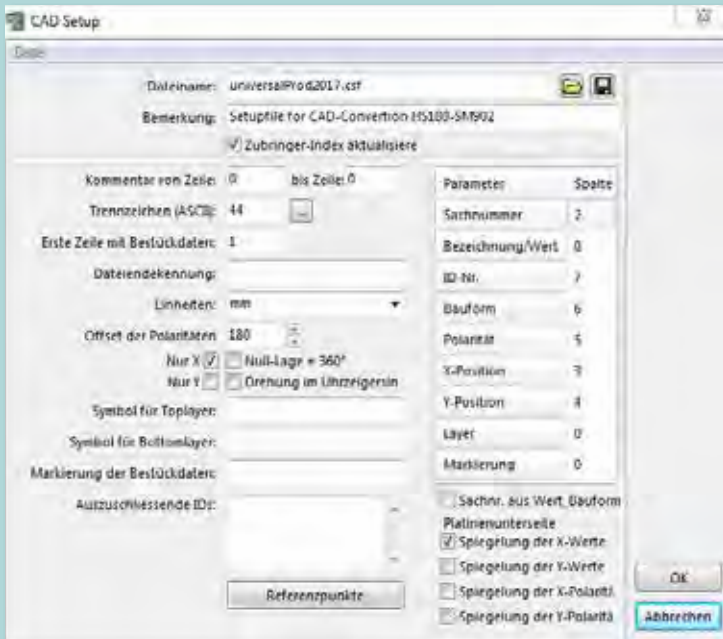

## Data transfer

Any data can be converted from CAD and saved as compatible data to FRITSCH in relevant projects. The positions are automatically transferred. PCBs haven't to be taught in manual. Also the feeder mapping at the semi-automatic machine can be manually or automatically adopted. With the connecting of a paternoster to a **SM902** the existing component libraries can be automatically transferred.





# Software options

## Pick & place optimization

The variants with software support the user during his daily production of prototypes and small series. A current circuit board is virtually displayed on a monitor, accompanied by guiding information as seen in the illustration below. After starting the program, a green-marked feeder indicates, at which position the component has to be picked up from. The current component is displayed on the computer screen together with the PCB. To make the orientation easier, the current position of the placement head is also displayed.

The integrated measuring systems check every position the user goes to and only turn the vacuum on or off, if the right position is reached. By executing the defined steps, the workload and concentration of the user is remarkably reduced, as the reading of the built-up sheet is eliminated. Besides the pickup and placing position, the components polarity and rotation is also shown. All necessary data can be entered manually or imported from several CAD data. Different lists, like placement list or component list can be printed to prepare a production.

LM900	LM901	LMinline	LMdispense	SM902	SM902prof	MP904
				✓	✓	✓

## Laser-Pointer-Modul

FRITSCH provides with the Laser Pointer Module comfortable pick & place of wired components. The intelligent mechanical construction of the holder in combination with the software of the **SM902professional** enables an error-free and user-friendly assembling of wired components like LEDs in only a few moments. The local recognition of reference areas leads the user through the program and eliminates therefore incorrect assembling.

LM900	LM901	LMinline	LMdispense	SM902	SM902prof	MP904
					✓	



# System options

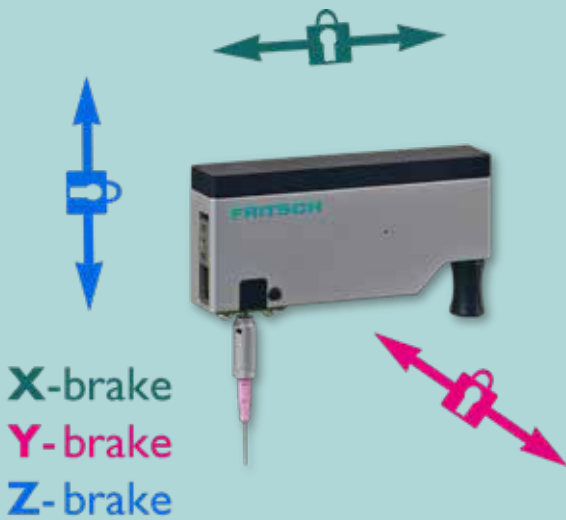

## X/Y-Locking

The X/Y-locking (fig.) provides precision while placing components or dispensing paste or glue. Individual axes can be locked. An automatic function independently locks the X and Y axes when the component are lowered or dispensing a dot. This facilitates especially the placing of Melfs.

904.905 Locking X/Y for **SM902**, **MP904**, **LM901**, **LMdispense**

LM900	LM901	LMinline	LMdispense	SM902	SM902prof	MP904
	✓	✓	✓	✓	✓	✓

## Fine-Pitch Option

904.715 Fine-Pitch option for **SM902**  
X/Y/Z -locking and X/Y-fine adjustment table for the pick & place of Fine Pitch components. The camera and color monitor display exactly the enlarged component to assist the user by picking and placing of Fine Pitch.

904.716 Fine-Pitch option for **SM902professional**  
X/Y/Z -locking and X/Y-fine adjustment table for the pick & place of Fine Pitch components. The camera and color monitor display exactly the enlarged component to assist the user by picking and placing of Fine Pitch.

LM900	LM901	LMinline	LMdispense	SM902	SM902prof	MP904
	✓		✓	✓	✓	✓

## Z-locking

The Z-locking enables the hold of the components in a position of levitation close to the PCB. This simplifies the assembling of Fine-Pitches and non-standard components because an exact calibration between PCB and component is possible.

904.906 Z-locking for **LM901/SM902/MP904**

904.908 Z-locking for **LM901/SM902/MP904** with pedal control (no picture)

LM900	LM901	LMinline	LMdispense	SM902	SM902prof	MP904
	✓	✓	✓	✓	✓	✓



# System options

930.006 Line-dispensing module for **LM/SM** time-pressure-dispensing unit with pedal

LM900	LM901	LMinline	LMdispense	SM902	SM902prof	MP904
	✓	✓	✓	✓	✓	✓



## Vacuum table

A vacuum table can be integrated for the production of flexible circuit carriers.

This is placed in the work area and operated with an external pump. The strength of the vacuum can be regulated as required using two rotary controls.

LM900	LM901	LMinline	LMdispense	SM902	SM902prof	MP904
✓	✓	✓	✓	✓	✓	✓



## Magnetic table

The inexpensive magnetic table was also developed to hold foils or thin circuit boards. With six round magnets and four magnetic strips 10 x 50 mm it is easy to fix the carrier to be equipped.

LM900	LM901	LMinline	LMdispense	SM902	SM902prof	MP904
✓	✓	✓	✓	✓	✓	✓

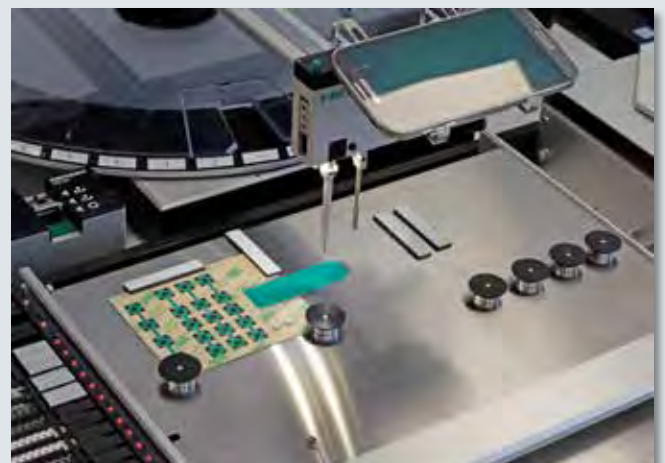



# Feeder and storage systems

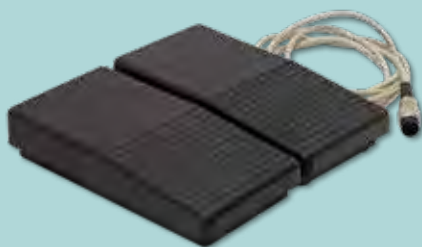
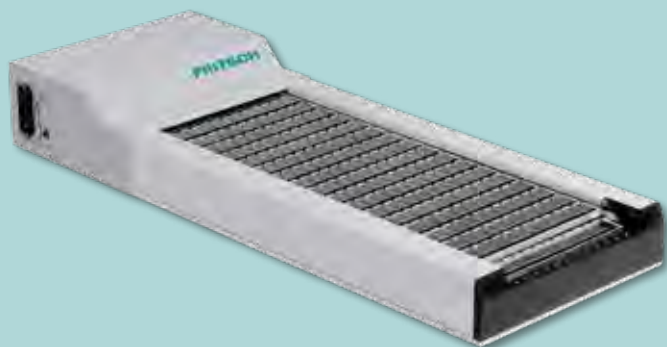

## Paternoster PT922

The Paternoster Mass Storage Magazine is the most sophisticated of the FRITSCHE feeder systems. Because of its narrow width Paternosters can be located at the side and/or back of Pick & Place machines.

LM900	LM901	LMinline	LMdispense	SM902	SM902prof	MP904
✓	✓	✓		✓	✓	✓

## More than 500 components can be fed

A single magazine can contain up to 504 components. This permits a high proportion of the required SMDs to be stored at the machine, which drastically reduces set-up times. A second magazine can be fixed to any FRITSCHE Pick & Place machine.

## Feeding of Loose Components, including ICs

The design of the Paternoster provides locations for 42 SMD Container Rails, which can be easily replaced and can present all kind of common components. The delivery of the components in every rail is possible by the optional FRITSCHE SMD Rail Units

## Control

The containers can be called up in different ways: The double footswitch with forward and reverse switches can be used to step through the rows by briefly depressing one or the other switch or to smoothly move through several rows by fully depressing one switch at a time.

## Semi Automatic Operation

In conjunction with FRITSCHE Pick & Place Machines **SM902** and **LM901** the Paternoster can be used to its full potential. The software of these systems is already set up to control one or more of these magazines. The required SMDs are automatically called up and positioned for convenient pick up.

## ESD Protected

The design of the Paternoster took full account of ESD compatibility so that all relevant machine components are electrically conductive. This ensures 100% protection from static charges and their damaging effects.



# Feeder and storage systems

## Feeders

- 922.110 Rail Unit with 12 small SMD Containers for loose components
- 922.310 Rail Unit with 3 large SMD Containers for loose components
- 922.322 Insert SO8- SO16 for large SMD-Containers
- 922.323 Insert SO16L- SO28 for large SMD-Containers
- CS.0001.00 Large SMD Container (left)  
Internal dimension 24 mm x 74 mm x 6 mm  
Storage Capacities: approx. 1000 Mini Melfs with IC Insert: 21 x SO16 or 8 x SO24
- CS.0002.00 Small SMD Container (right)  
Internal dimensions 17 mm x 24 mm x 6 mm  
Storage Capacities: approx. 250 Mini-Melfs

LM900	LM901	LMinline	LMdispense	SM902	SM902prof	MP904
✓	✓	✓		✓	✓	✓

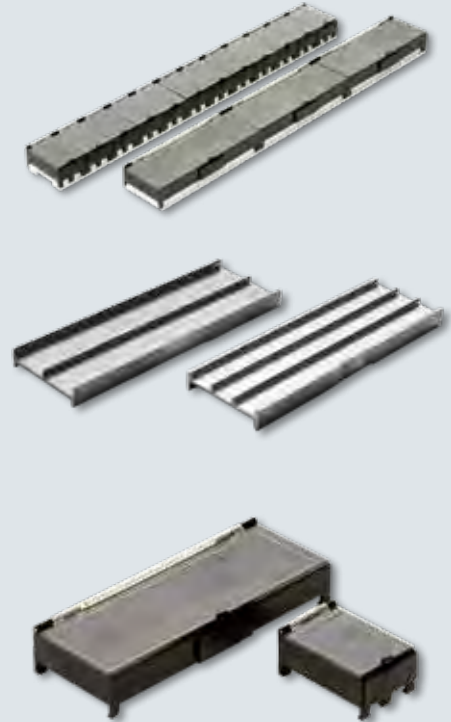

## 922.504

Paternoster with 504 small SMD Containers

Scope of delivery:

foot switch

rails, each with small SMD Containers

## PT922.505

Paternoster without SMD Containers

Scope of delivery:

foot switch

## Technical details

Dimensions: 945 mm x 345 mm x 126 mm  
number of feeder rows: 42 / 504 containers  
weight: 19 kg

LM900	LM901	LMinline	LMdispense	SM902	SM902prof	MP904
✓	✓	✓		✓	✓	✓



# Feeder and storage systems

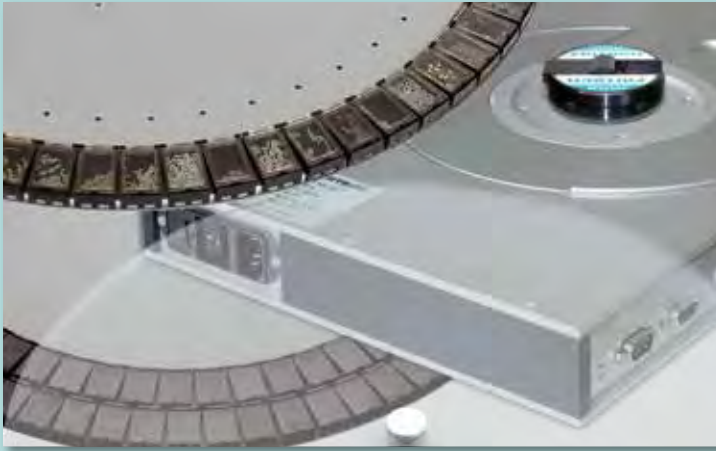

## Easy and secure storage

To protect the contents of the carousels from dust, the cut out in the cover is replaced with the sold panel, and the whole cover is lowered onto the bins by operating the cam lever. The simpler types of carousels can also be equipped with a clear dust cover. The compact design and modest height of the carousels enables the space saving storage of several configurations.

## Different versions

The simplest of the carousel arrangements - manual carousel support and corresponding carousels - are manually indexed during picking and placing. The motorised carousel drive is controlled by a double foot switch; one switch for clockwise, the other for counter clockwise rotation. Brief pressing of the switches achieves an index by one bin, longer pressing rotates the carousel smoothly until the switch is released. The processor controlled version is controlled by the FRITSCH system software. The required bin locations are transported via the shortest route automatically to the pick up position. The appropriate carousels have covers with inserts that have suitable cut outs for the size of bin used. Both drive systems are controlled by the software of the semi-automatic machine **SM902**.



## Cam Lock System

Each feeder plate with a fast exchangeable system has an intake device for the easy and fast placing of parts on the drive. This device makes sure that it is always in the correct position. It is thus not necessary to home the drive after interchanging the rotary plate. Some rotary plate variations are equipped with an extraction element in the lid – either for wide or narrow containers. This element defines the exact position of extraction. It is thus not possible to accidentally remove anything from the wrong container.

## ESD protected

All components of the carousel system up to the transparent ESLON cover are conductive as standard, so that ESD protected storage and assembly can be guaranteed.

LM900	LM901	LMinline	LMdispense	SM902	SM902prof	MP904
✓	✓	✓		✓	✓	✓





# Feeder and storage systems

## Carousel Supports & Carousel Drive

- 920.601 Carousel Support for manual indexing, antistatic suitable for carousels 920.015, 920.066, 920.090, 920.124, 920.125 and 920.450
- 920.602 Carousel Support for manual indexing, antistatic large base with support plate for cover 920.462/463. for carousel 920.450 and 920.090
- 921.205 Motor-controlled Carousel Support for **LM & SM** serie

LM900	LM901	LMinline	LMdispense	SM902	SM902prof	MP904
✓	✓	✓		✓	✓	✓



## Carousels

- 920.450 Carousel with 45 compartments antistatic, for Carousel Support 920.601 and 920.602
- 920.451 Carousel with 45 compartments antistatic, for Motor-controlled Carousel Support 921.205
- 920.090 Carousel with 90 compartments 45 antistatic double trays for Carousel Support 920.601 and 920.602
- 920.091 Carousel with 90 compartments antistatic, for Motor-controlled Carousel Support 921.205
- 920.124 Carousel with 124 Containers Container CS.0002.00 antistatic, for Carousel Support 920.601



# Feeder and storage systems

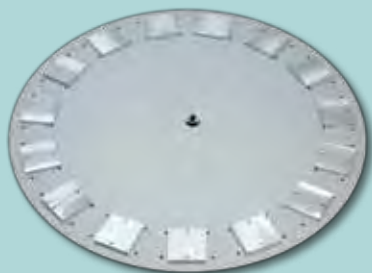

## Carousels

920.015 Carousel with 15 Mini-Tray-Acceptances for Carousel Support/Drive 920.601

920.066 Carousel with 6 Arc shaped rail units 922.116 antistatic for Carousel Support 920.601

LM900	LM901	LMinline	LMdispense	SM902	SM902prof	MP904
✓	✓	✓		✓	✓	✓

## Covers

920.460 Cover without extraction cut out suitable for Carousel 920.450, 920.451, 920.090 and 920.091

920.462 Cover with extraction cut out „45“ for safety extraction and a low-dust-storage suitable for Carousel 920.450, 920.451 and Carousel Support/Drive 920.602 and 921.205

920.463 Cover with extraction cut out „90“ for safety extraction and a low-dust-storage suitable for Carousel 920.090, 920.091 and Carousel Support/Drive 920.602 and 921.205

LM900	LM901	LMinline	LMdispense	SM902	SM902prof	MP904
✓	✓	✓		✓	✓	✓



# Feeder and storage systems

## Carousel Drive

921.505 Processor Controlled Carousel Drive with double foot switch and USB cable, addressable from PC with SM902 Software via USB interface, antistatic for Cam Lock Carousel 920.415, 920.453, 920.466, 920.468 and 920.490

LM900	LM901	LMinline	LMdispense	SM902	SM902prof	MP904
				✓	✓	✓



## Carousel with Cam Lock System

920.453 Carousel with 45 compartments with Cover Cam Locked for processor controlled Drive 921.505.01



920.490 Carousel with 90 compartments with Cover Cam Locked for processor controlled Drive 921.505.01



920.466 Carousel with 6 Arc shaped rail units 922.116 with Cover Cam Locked for processor controlled Drive 921.505.01

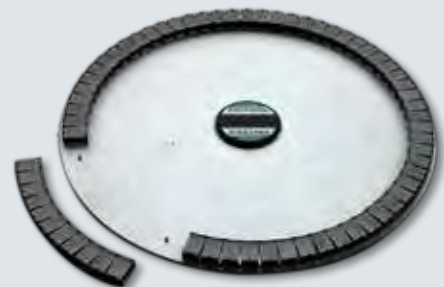

920.415 Carousel with 15 Mini-Tray-Acceptances antistatic for processor-controlled Carousel Support 921.505.01



LM900	LM901	LMinline	LMdispense	SM902	SM902prof	MP904
				✓	✓	✓



# Feeder and storage systems

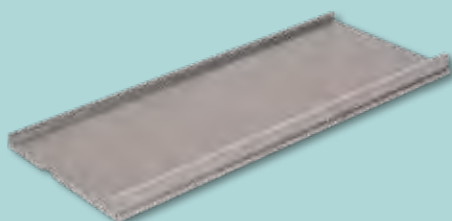
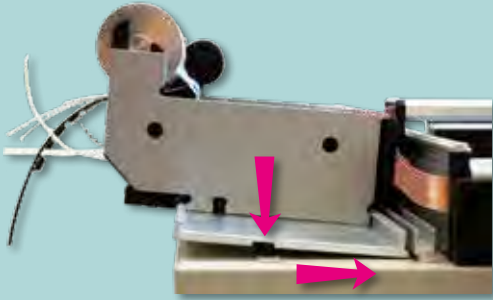

## Feeder and storage systems

All FRITSCH Manipulators are equipped with the FRITSCH Rail System therefore the following feeders and storage systems can be implemented.

### IC-Dispenser - stick feeder

- |         |   |
|---------|---|
| 942.208 | IC-Dispenser for SO 8, SO 14, SO 16<br>tube width 7,9 mm, overall width 15 mm   |
| 942.220 | IC-Dispenser for PLCC 20<br>tube width 12,5 mm, overall width 22 mm   |
| 942.228 | IC-Dispenser for SO 8L, SO 16L, SO 20L,<br>SO 24L, SO 28L, VSO 40 Gehäuse, PLCC 28<br>tube width 15,4 mm, overall width 22 mm |
| 942.244 | IC-Dispenser for PLCC 44<br>tube width 20,1 mm, overall width 27 mm   |
| 942.252 | IC-Dispenser for PLCC 52<br>tube width 22,6 mm, overall width 30 mm   |
| 942.268 | IC-Dispenser for PLCC 68<br>tube width 27,7 mm, overall width 35 mm   |
| 942.284 | IC-Dispenser for PLCC 84<br>tube width 32,8 mm, overall width 40 mm   |
| 942.901 | IC-Dispenser customized   |

### Tape feeder

- |         |   |
|---------|---|
| 943.008 | Tape feeder for 8 mm SMD Tape<br>overall width 11 mm  |
| 943.012 | Tape feeder for 12 mm SMD Tape<br>overall width 15 mm |
| 943.016 | Tape feeder for 16 mm SMD Tape<br>overall width 19 mm |
| 943.024 | Tape feeder for 24 mm SMD Tape<br>overall width 27 mm |
| 943.032 | Tape feeder for 32 mm SMD Tape<br>overall width 35 mm |

### Mounting Rails

- |         |                           |
|---------|---------------------------|
| 940.255 | Mounting Rail 255 mm      |
| 940.306 | Mounting Rail 306 mm      |
| 940.426 | Mounting Rail 426 mm      |
| 940.470 | Mounting Rail rear 470 mm |
| 940.570 | Mounting Rail rear 570 mm |



# Feeder and storage systems

## Universal Tape Strip Feeder

- 941.112 Universal Tape Strip Feeder for various widths with 6 rails for 5 tapes. (Max. 11 x 8 mm tape possible). With two spring-loaded tape support rails
- 908.095.023 Rail for Tape Strip Feeder
- 908.095.024 Spring-loaded tape support rail

## Reel Support Stand

- 943.101 Reel Support Stand feeding tapes for all SMD tape feeder TF943, for example 5 pieces 8 mm, reel diameter 180 mm
- 943.103 Reel Support Stand, reel diameter 100 mm
- 943.102 Reel Support Stand, reel diameter 330 mm

## Other Support Stand and Accessories

- 941.101 Tape Strip Dispenser stand with Rail Unit 941.124 with 24 Mini feeders for tape strips
- 941.124 Rail Unit with 24 Mini feeders for tape strips
- 940.701 End Support for TF943 on Mounting Rail
- 944.136 Waffle Tray Support 136 x 316
- 944.316 Waffle Tray Support 316 x 316

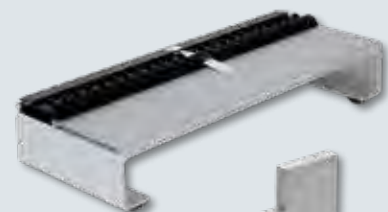

# Feeder and storage systems



## SMD-Container

FRITSCH SMD Containers are available in two sizes. These boxes form the building blocks for several feeders and are arranged on rails.

SMD Containers exhibit the following strengths:

### Easy operation with self opening clear lid

Good view of the contents through the clear lids which can be opened by lightly touching the catches with the Pick Up Nozzle. The lids are held fully open by built in springs, giving quick and easy access to the components.

### High flexibility

The containers can be replaced individually or in Rail Units. This allows the pre arrangement of components needed for a project without having to transfer them from one container to another and to have the whole range of component values available at the work place. The rail units can also be used with the Paternoster and the carousel.

### Short Set Up Times

The simple insert reduces set-up times to a minimum. The individual SMD container can be rearranged with an easy clip on the same or another rail.

## Simple and Safe Storage

The Rail Units are intended to be stored in our Drawer Units which provide easy access to the SMD Containers. The supplied labels ensure that components can be easily identified. When the lids are closed the components are securely held and protected from dust.

## ESD Protected

All the component parts of the SMD Containers are conductive so that ESD protected storage is ensured.

### CS.0001.00 Large SMD Container (left)

Internal dimension 24 mm x 74 mm x 6 mm  
Storage Capacities: approx. 1000 Mini Melfs  
with IC Insert: 21 x SO16 or 8 x SO24

### CS.0002.00 Small SMD Container (right)

Internal dimensions 17 mm x 24 mm x 6 mm  
Storage Capacities: approx. 250 Mini-Melfs







# Feeder and storage systems

922.110 Rail Unit with 12 small Containers (left)

922.310 Rail Unit with 3 large Containers (right)

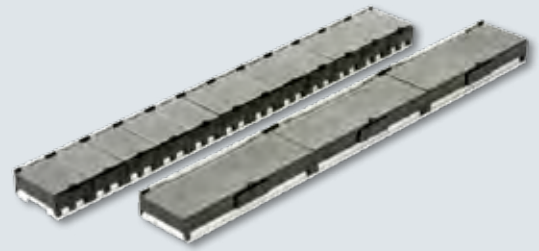

922.322 Insert SO 8 - SO 16 for large Containers (left)

922.323 Insert SO 16L - SO 28 for large Containers (right)

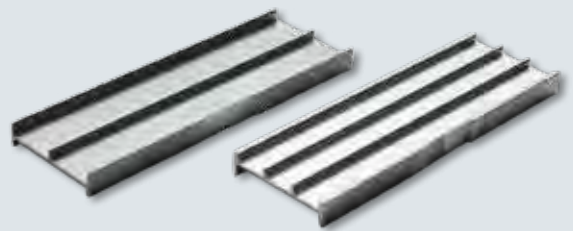

922.113 Support with 36 small Containers with 3 Rail Units 922.110

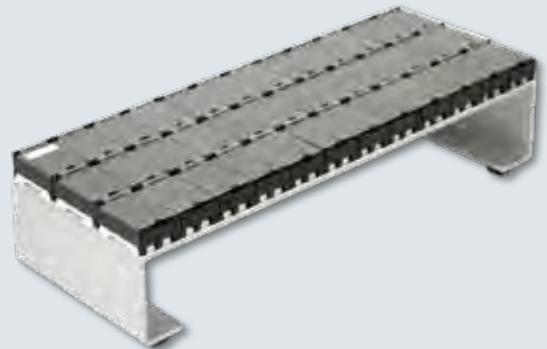

922.313 Support with 9 large Containers with 3 Rail Units 922.310

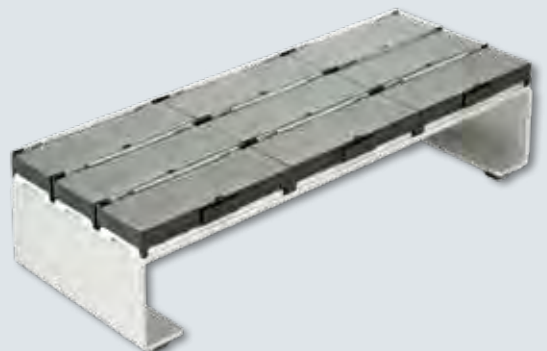

922.115 Support 36 small Containers with transparent lids incl. 3 LED-Rails with 12 LEDs, connection cable and rebuilt

940.312 Re-Mounting Rail for 3 x 12 LEDs to use for any rails at SM to store three Rail Units 922.110 or 922.310

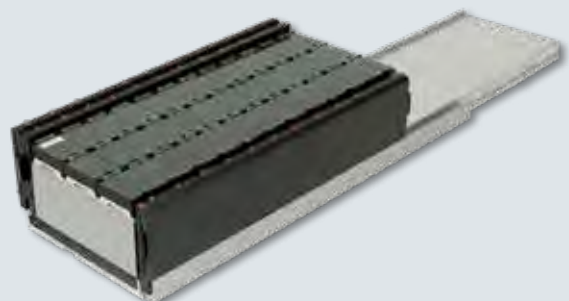

# Feeder and storage systems

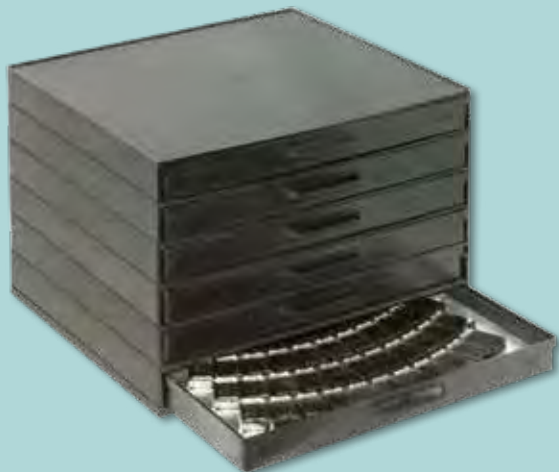

## Drawer Units

- 922.207 Antistatic Drawer Unit with 6 drawers, 1 drawer filled with 7 Rail Units 922.110, providing 84 small Containers

## Rail Unit for Carousel

- 922.116 Curved rail unit for Carousel 920.466 antistatic with 11 Containers CS.0002.00.

- 922.206 Drawer Unit antistatic with 6 drawers, 1 drawer filled with 6 curved rail units 922.116



# SM902 systems accessories

## LED Rails

940.802 LED Rail with 2 LEDs  
pitch spacing between LEDs 19 mm  
length 38 mm

940.810 LED Rail with 10 LEDs  
pitch spacing between LEDs 11 mm  
length 110 mm

940.812 LED Rail with 12 LEDs  
pitch spacing between LEDs 19 mm  
length 230 mm

940.820 LED Rail with 20 LEDs  
pitch spacing between LEDs 5,5 m  
length 110 mm

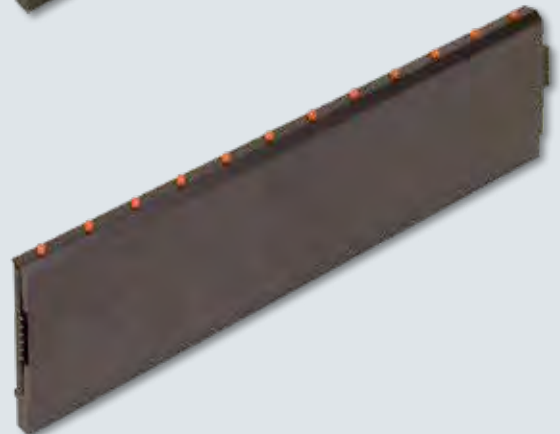

LM900	LM901	LMinline	LMdispense	SM902	SM902prof	MP904
				✓	✓	✓



# SM902 systems accessories

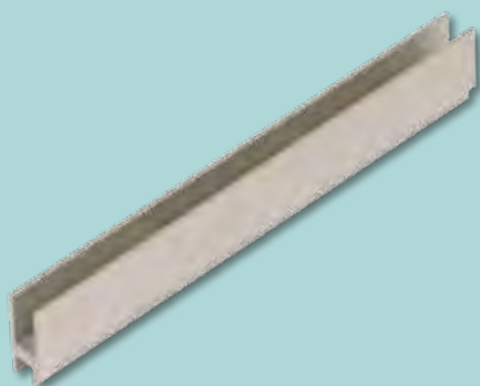

## Connecting Cable between LED Rails

For connecting LED Rails when direct plug in isn't possible, for example on a corner

940.830 length 30 mm

940.840 length 150 mm

940.916 LED Rail Support Strip Extension  
length 120 mm  
for combining Mounting Rails  
940.306 / 940.570 (backside)  
940.426 / 940.470 (leftside)

LM900	LM901	LMinline	LMdispense	SM902	SM902prof	MP904
				✓	✓	✓



## Manual flipping-station

Anyone working on the production of prototypes with bulk material components knows the problem. Not for nothing has the term „bird food“ naturalized for it: The parts are completely random mess, partly on the back. Or the parts are correct, but the operator must turn them anyway, because the polarity marking is mounted on the underside - important especially for LED components. Therefor this unit consists of an ESD fleece, on which the component is turned with the pipette and a mirror, which shows the polarity.

Order no.: 922.203

LM900	LM901	LMinline	LMdispense	SM902	SM902prof	MP904
✓	✓	✓		✓	✓	✓

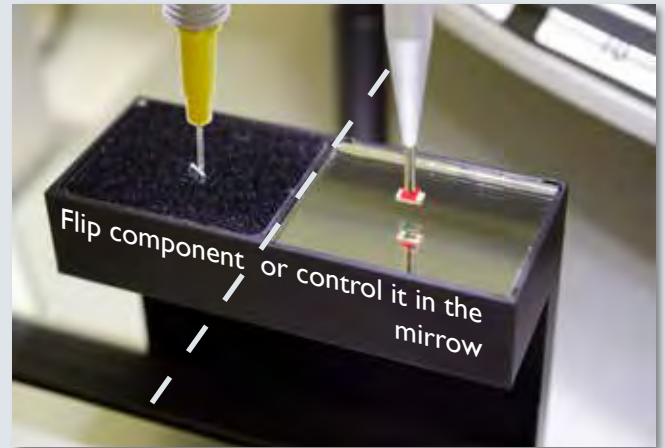

## Component flipping-station

Simply place the component into the flipping station, move the assembly nozzle from the flipping area through the sensor barrier and the component is flipped over. This process takes less than one second and enables the removal of the parts the right way up.

Order no.: 922.201

LM900	LM901	LMinline	LMdispense	SM902	SM902prof	MP904
✓	✓	✓		✓	✓	✓



## Flipping-station for loose components

After filling the destined tray with loose components the user is picking and placing the correct laying pieces. Only the wrong sided components remain. Pressing a button all are turned and working can go on without a rest. The flipping station is available for all manipulators and semi-automatic machines of the 900, 901, 902 and 904 range. Connected with a separate power supply there is the possibility to be integrated easily with pure manual assembling machine or wherever.

Order no.: 922.202

LM900	LM901	LMinline	LMdispense	SM902	SM902prof	MP904
✓	✓	✓		✓	✓	✓



# Accessories



## Camera

By means of a camera attached directly to the assembly head, you can view the entire pick & place process – enlarged on a monitor.

- 927.000 Flexible fixture complete without camera kit
- 927.008 Camera attachment for LM- and SM-systems; with colored camera WAT, objective lens, cable, power supply, frame grabber, PC-card and software
- 927.010 Camera attachment for LM- and SM-systems; with colored camera WAT, objective lens, cable and power supply
- 927.011 Camera attachment for LM- and SM-systems; with colored camera WAT, objective lens, cable, power supply and 17" TFT colored monitor
- 927.014 Camera attachment for LM- and SM-systems; with HD colored camera digital microscope

LM900	LM901	LMinline	LMdispense	SM902	SM902prof	MP904
	✓	✓	✓	✓	✓	✓

## Compressor

910.020 Compressor suction capacity: 17 l/min

910.030 Compressor suction capacity: 50 l/min

LM900	LM901	LMinline	LMdispense	SM902	SM902prof	MP904
	✓	✓	✓	✓	✓	✓



## Work space illumination

913.001 Lamp for manipulator

LM900	LM901	LMinline	LMdispense	SM902	SM902prof	MP904
✓	✓	✓	✓	✓	✓	✓







# dispenseALL

Whether in the development laboratory, in series production, in special applications or for the extension of existing production lines - the dispenseALL420 offers the solution for your dispensing challenge.

The **dispenseALL420** automatic dispensing unit is in the tradition of the successful SMT placement systems from FRITZSCH SMT. As a flexible system with many options and short set-up times, it is suitable for dispensing and jet tasks in electronics and mechanics. The manufactured quantities range from prototypes over small up to medium lots.

The universal carrier unit allows the use of up to three different dispensing valves simultaneously. Each dispensing head has its own motor drive with integrated encoder for position control. This allows any height on the workpiece carrier approach.

Its modular design, shortest set-up times for various products and easy programming with a graphical user interface make the **dispenseALL420** a highly economical investment. The dispensing machine offers a great deal of flexibility thanks to numerous standard options. In addition, the **dispenseALL420** forms a universal platform on which customer-specific requirements can be easily implemented

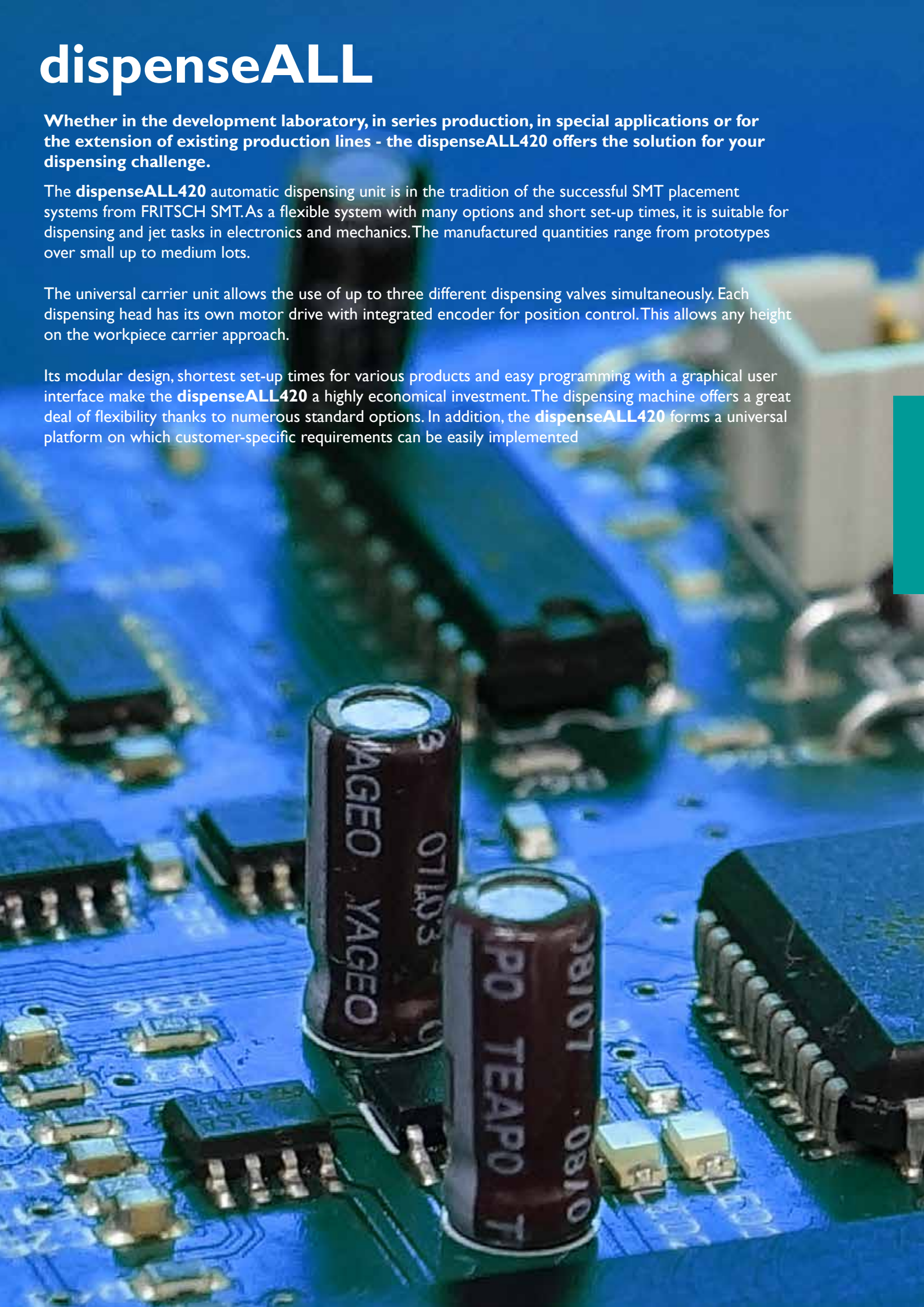



# dispenseALL420

## Platform

The full-automatic dispensing system **dispenseALL420** is a flexible machine for dispensing of solder paste, glue, sealant, underfill, conformal coating and more. The range of application are prototyping, serial production, special applications or the extension of production lines. Dispensing tasks are as individual as the used media. Therefore the dispensing machine **dispenseALL420** offers a lot of options for every application.

## Range of applications

Flexible system for the dispensing of lines, circles and areas for underfill, coating, dam and fill, potting and more.

## Drive

**X-Y Axis:** Direct-current motors with contactless linear encoder, resolution 0.5  $\mu\text{m}$ .

**Z-Axis:** Direct-current motors with encoder, resolution 1.6  $\mu\text{m}$ .

## Economics

Modular system, shortest set-up times, user friendly software.

## Options

- Standalone or inline
- Dividable frame
- max. 3 dispensing heads
- Vacuumtable for flexible PCBs
- Heating plates for heating assemblies





# Overview

## Dispensing heads

The basic equipment of the dispensing machine **dispenseALL420** offers a unit with up to 2 dispensing heads. It can be enlarged optionally up to 3.

## Dispensing valves

The **dispenseALL420** covers a wide spectrum of tasks and can therefore individually adapted to respective application.

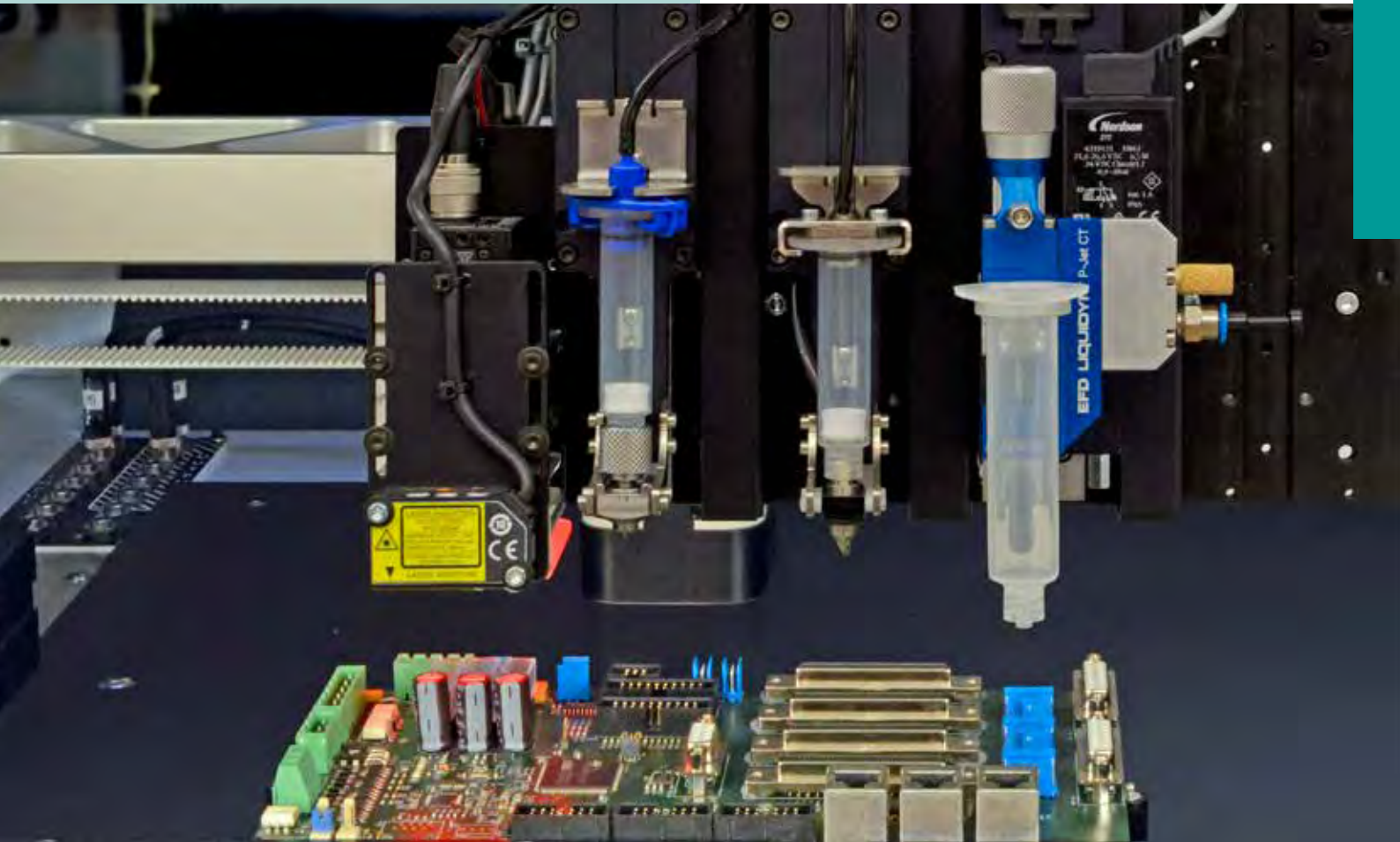

## Application

The flexibility and adaptability of the **dispenseALL420** enables a cost-effective and fast realisation of most varied uses in the automated assembly and production.

## Software

The structured software applications combined with different features offer the user a significant facilitation of daily production.



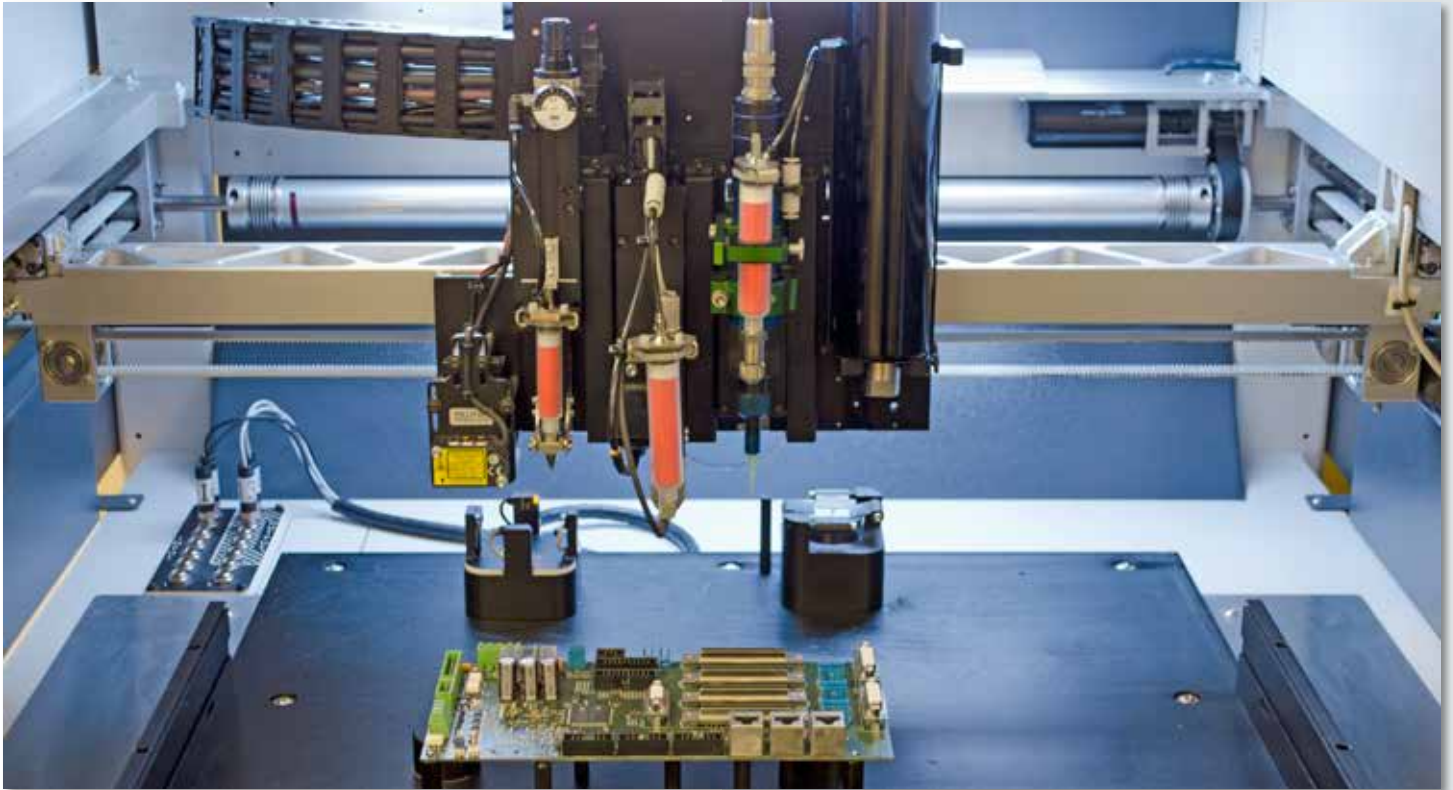

The **dispenseALL** axis have ultramodern belt drives which are moved by DC-motors in combination with a high resolution linear measure system which is fixed along the axis. The axis are constructed weight-optimized to minimize the acceleration forces while dispensing. This enables the use of a belt-drive and a screw drive isn't necessary. With regard to Cost of Ownership this is an enormous advantage and offers in case of service and repair work a high potential of cost saving compared to screw drive.

The axis of the **dispenseALL** combine the two advantages of both systems optimal: High dynamic of the belt drive with the accuracy of the linear measurement. The high resolution of the encoder system of  $0.5 \mu\text{m}$  is optimal completed by the axis controller with a scanning frequency of  $100 \mu\text{m}$  each axis. Because of this also high dynamic drives can be performed extreme accurately.



# Dispensing heads

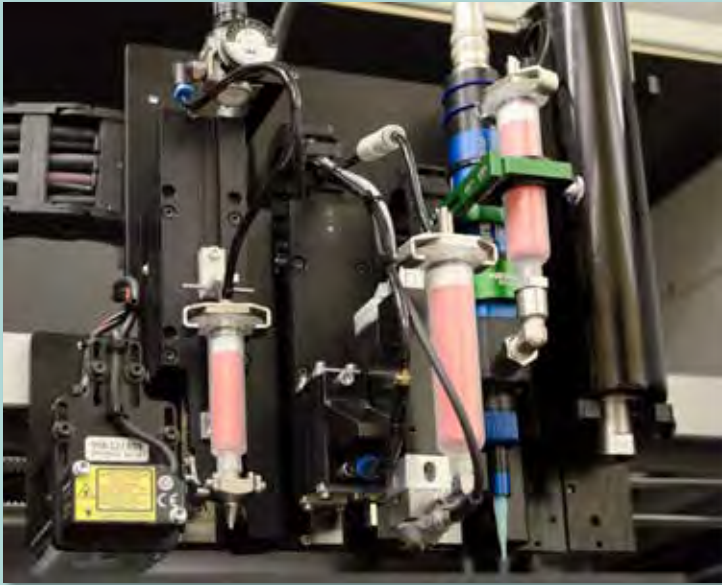

## Standard dispenser head

Each dispenser head has its own axis-drive. A DC-motor with encoder is therefore in use and enables a free head positioning at any height. The motor-axis allows the fast as well as very exact positioning of the dispensing valves for dispensing. The valves' slim construction make the simultaneous use of the carrier unit possible.



## Parallel dispensing

The dispensing machine software supports simultaneous dispensing on all dispensing heads. This allows recurrent dispensing to be made on up to three different uses simultaneously. The valves are arranged on the carrier unit in a row. Thus, only the appropriate distances between the metering valves need to be adjusted. In series production, the dispensing capacity can be almost tripled.



# Dispensing valves

## Universal platform

The universal carrier unit is the centrepiece of the **dispenseALL**. Depending on application up to 3 dispensing axis and heads can be installed. Each axis has a motor-drive with encoder to move freely to any height. Therefore contactless dispensing operations are possible.

## Time-pressure dispenser valve

The simple means of attaching the valve makes it particularly robust and low-maintenance. The adjustable pressure affects the cartridge after a short period. The desired amount can easily be set in the software. Typical applications for this dispensing valve are dot- and line dispensing.

## Precision dispenser valve

In the case of the precision dispenser valve, additional parameters such as temperature and the fill level of the cartridge are collected. The processor control regulates these values, the pressure and the time of the dispensing impulse in order to achieve the highest repeat accuracy. The processor control enables the dispenser valve to be mounted very easily. This makes the valve remain robust and low-maintenance in spite of the highest accuracy.

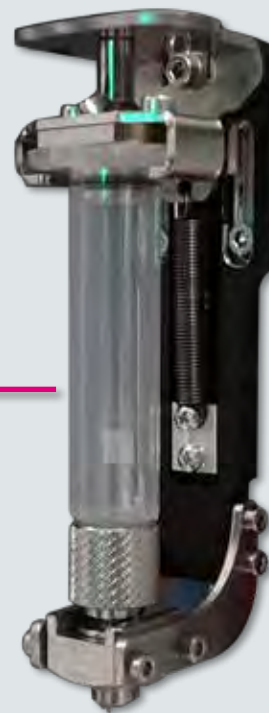



# Dispensing valves



## Volumetric dispensing system

Suitable for the accurate dispensing of watery to pasty media such as SMD adhesive, soldering paste or silver conductive adhesive. The medium is transported with as little application of pressure as possible. The actual dispensing is carried out by being transported by the spindles. This means the application of pressure of the material is kept as low as possible.



## Jet dispensing system

The very fast piezo dispenser valve dispenses amounts at a very high speed. In the case of a dispensing frequency of up to 150 dots/second, it is possible to constantly apply very small amounts. The high dispensing frequency enables the apply of smallest quantities as well as larger quantities with only one head.



## Spray dispensing

The spray valve can handle low to medium viscosity materials. It is most suitable for oils, separating agents and alcohol. The valve is made for the attachment to a controller and a material feeding container like a syringe or pressure tank. The slim construction allows to easily retrofitting to existing systems.



# Applications

## Dispensing solder pastes

In applications where no stencils can be used for the paste print, dispensing the solder paste by way of a dispenser is a flexible and accurate alternative. The highest level of precision is necessary when manufacturing interconnect devices. Besides the positioning accuracy of the machine, even the smallest amounts of paste need to be dispensed with a high level of repeat accuracy and long-term stability.

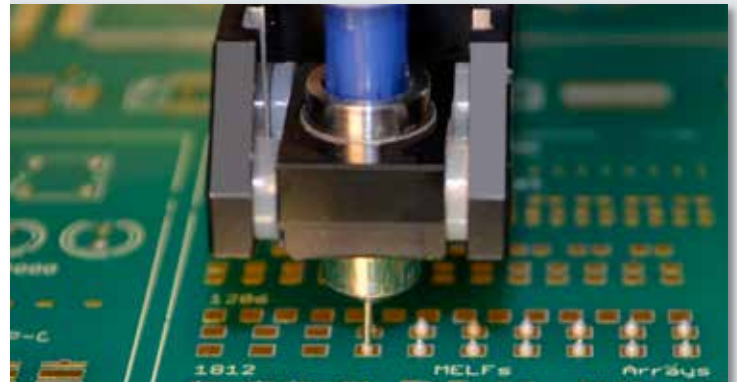

## SMD glue dispensing

Although in the meantime, components are no longer glued in the production of SMTs where possible, in order to alleviate subsequent repair work, for example, there still are applications where components are glued. Especially with heavy structural shapes such as power components or plugs, gluing ensures the mechanical stability of the circuit. In addition, mechanical powers can be dissipated better even in smaller components.



## Silver conductive paste dispensing

Silver conductive pastes can be applied as an alternative to traditional solder paste anywhere that interconnect devices or components are sensitive to temperature and a standard soldering process cannot be used. In comparison to solder paste, silver conductive pastes are more cost-intensive and require more care in handling and storing.



## Underfill dispensing

Underfill is used in interconnect devices for example with BGAs and flip chips to compensate the temperature expansions between the actual chip and the interconnect device. The underfill significantly improves the reliability and the service life.



# Applications

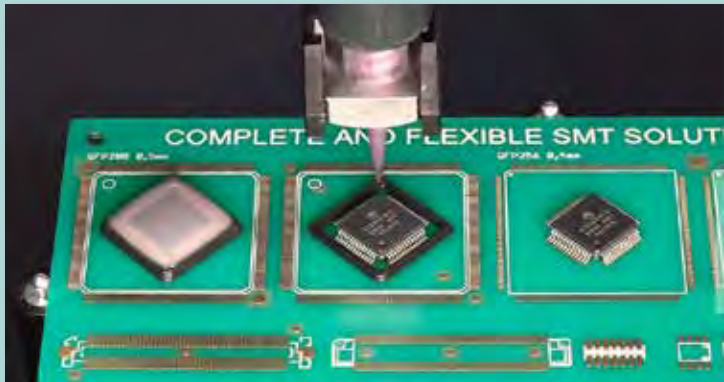

## Dam and fill

Two different materials are used in the dam and fill process. A high and a low-viscous substance. First the material with high viscosity is dispensed as a dam around. Then the area inside of the dam is filled with the low viscous material (fill) to coat the circuit completely.

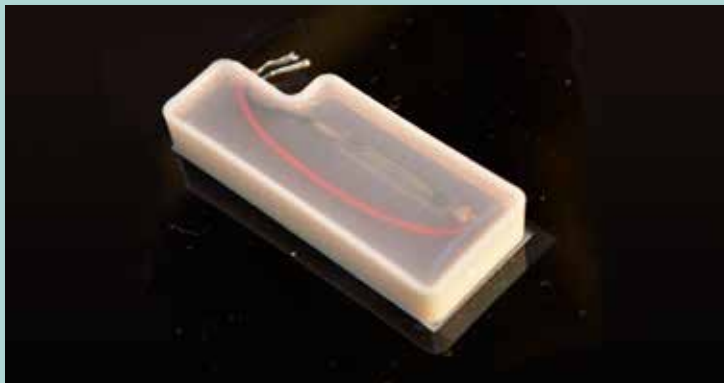

## Potting

Components and top performers are mounted in cases which are filled with different media to enlarge their life-time. Therefore FRITSCH offers the ideal solution to guarantee a solid and safe processing. In one or more operations the potting can be made with different media. The potting process is mainly used by higher-volume packages like the encapsulating of spools but also in power electronics.



## Dispensing lubricants

A safe and precise support respectively treatment of gears is a special daily task for the user and no longer a rarity. Processing-safe alternatives are necessary to replace the manual apply of lubricants. The automated applying of lubricants guarantees constant conditions to increase the life-time of components.



## Dispensing locking varnish

Dispensing mechanical components requires regularly the application in depressions and holes or along existing contours. The easy-to-handle Software of the dispense-ALL enables the programming by teach in as well as the grafical editing similar to a CAD-program.





# User-friendly Software

## Operation and programming

The clearly laid out software guides the user step by step to his goal. To setup a new project or alter an existing one, the parameters can be simply chosen with a mouse click. There is also a detailed help menu for each function.

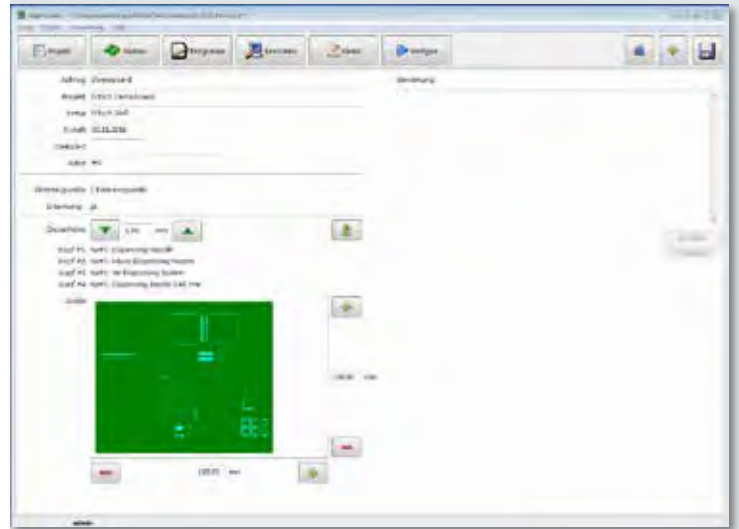

## Component library

The integrated component library contains over 450 component models. This represents one of the largest libraries on the market today. All content items can be edited or new ones can be created.

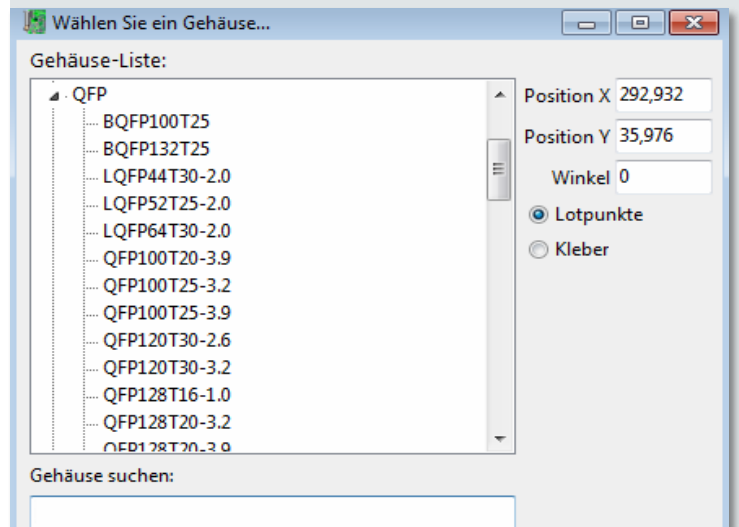

## Component editor

If components, which are not part of the default library, need to be placed, a graphical editor is used to create a new component body in just a few steps.

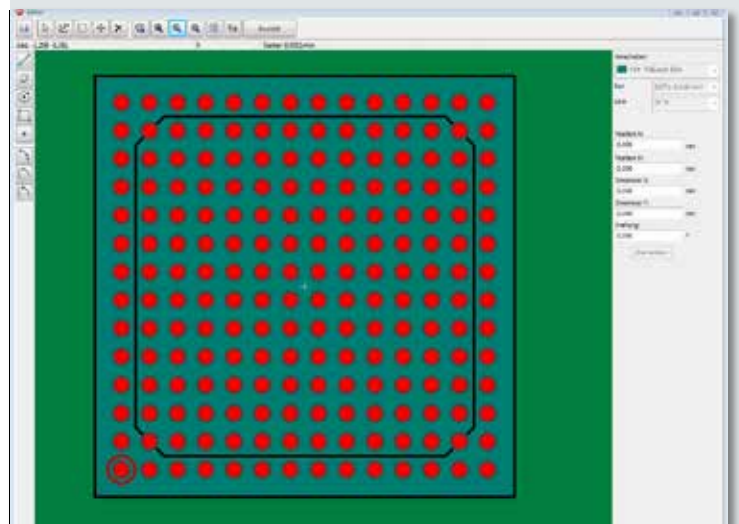

# Simple project development

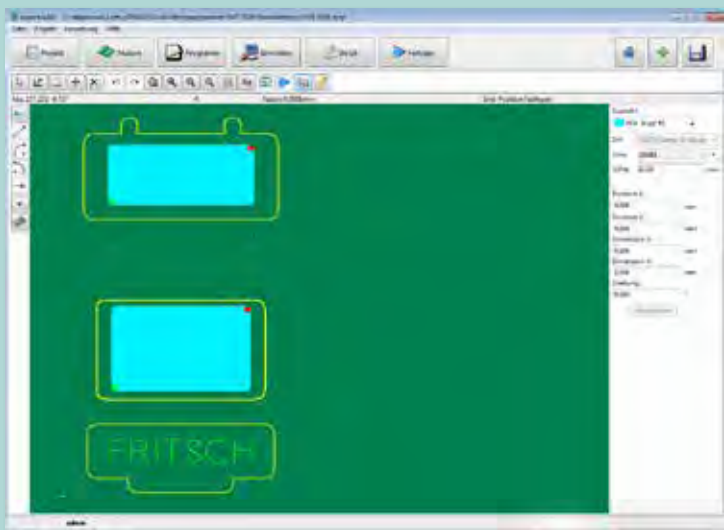

## Easy programming

Depending on application the user has various possibilities to design the program. Lines and curves can be drawn easily in the virtual editor. Dispensing dots can be taken from existing data or taught in.

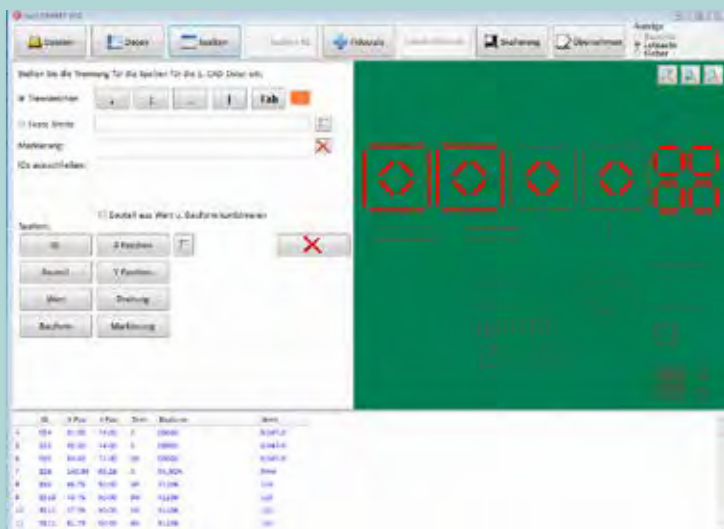

## Data transfer

By means of a format editor, files from all CAD systems can be adapted with a few self-explanatory operating steps. The conversion process takes very little time and can be done offline on a separate PC.

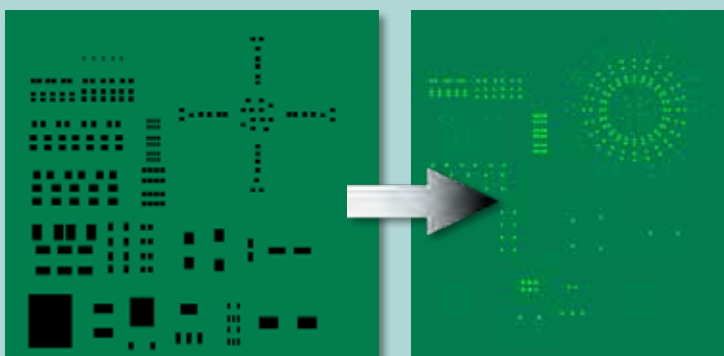

## Gerber data conversion

Common Gerber files are used to create dispensing points using template thickness and SMD pad information. Dot size, size and shape are easy to set and optimize for each component and pad on the board.



# Software options

## Dxf-Data conversion

By means of the X/Y-center coordinate and the drawing layer the allocation of the dosing position and quantity takes place.

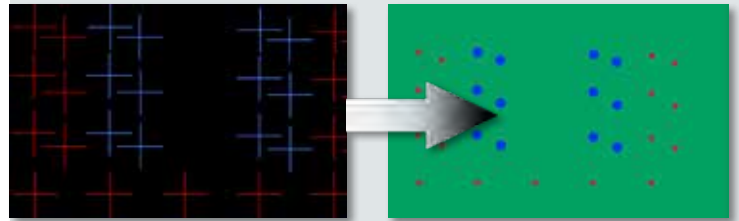

## Automatic fiducial recognition

To correct positions reference marks such as crosses, circles, rhombi etc. can be read in automatically. The camera captures the exact position of the circuit board before the dispensing begins.

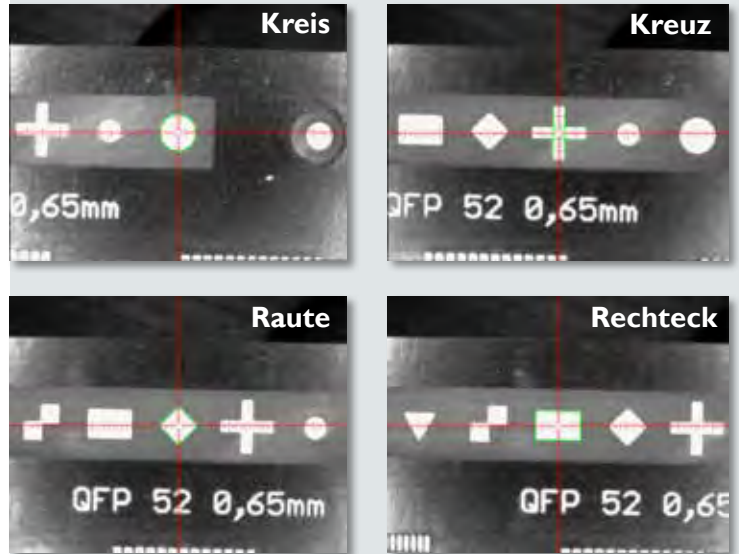

## Teach in

To create a project, the user drives to the particular position; a virtual dot is shown as an overlay in the camera window. The virtual dot can now be adjusted exactly and brought into the right position. After that, its position is logged into the dispensing project file.

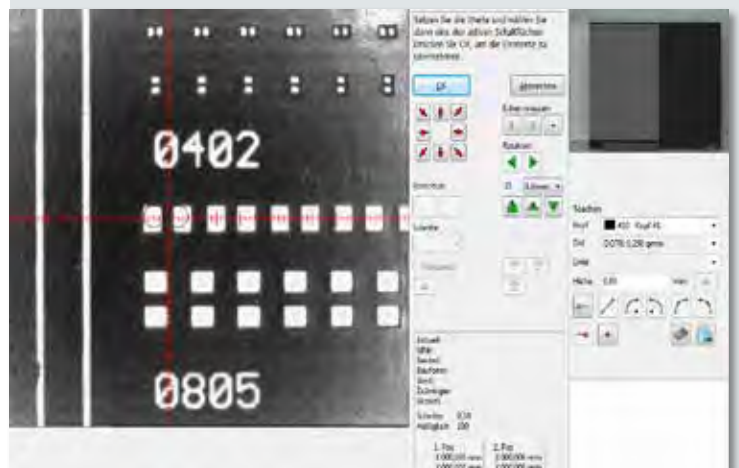

## PANetState

All machine messages are transferred to a separate PC on the network and displayed there. The user is informed i.e. if production is finished and can initiate further steps.





# Advanced working assistance

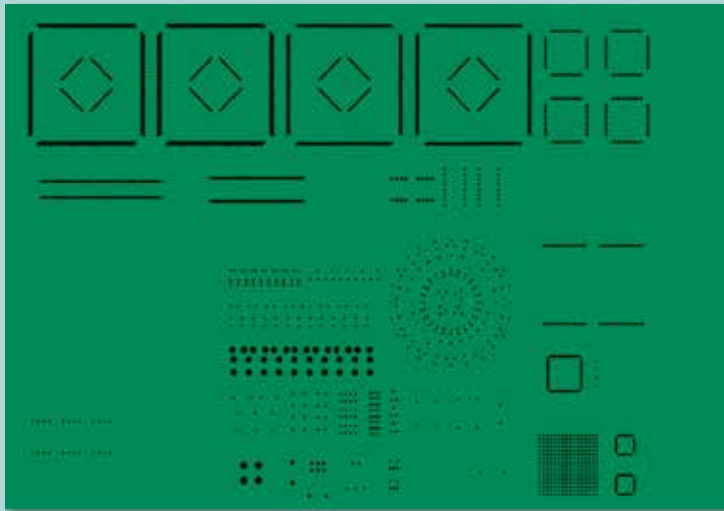

## Virtual dispensing plan

The virtual dispensing plan enables the preview of the dispensing result before the process starts. An image of the real PCB can be used as template. Therefore a fast and easy control of the dispensing result is possible. Editing capabilities like for example the moving and rotating of dots or lines complete the virtual circuit diagram to a valuable tool.

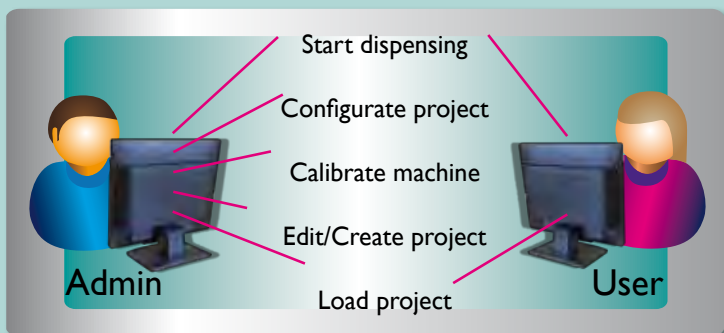

## User management

The user administration makes it possible to assign different rights to different users. The person who is able to edit programs or update component libraries can be defined, and other users can be locked out of these functions. These rights can be easily edited by clicking on the different production steps in the software.



## Remote Support

Remote access to your machine by our technicians is possible using the service kit, after having your approval. This connects us directly into your dispenseALL and the installed software to rapidly provide an overview of the machine's status if any questions occur. The remote support is free of charge while the warranty period.



# Conveyor systems

## Customization

By request the conveyor can be equipped with a customized intake for workholding fixture. This enables to handle even heavy or customized workholding fixture in the **dispenseALL**.

## Fast and easy

Especially in small series the stand- and changeover times should be reduced. Therefore the various conveyor systems are optimized. The justage of the PCB width as well as the positioning of the supporter pins below the circuit can be done without tools. Depending on application and local conditions the best conveyor for optimal transportation can be chosen:

- motorized width adjustment
- flat belt
- 3 zone conveyor
- one-sided batch conveyor from the left or right

## Stressless motion

To bring sensitive PCBs such as ceramic substrates or partial assembled PCBs safely to the dispensing position, the PCBs are slowly moved through a ramp of deceleration to the stopper and so the mechanical load is reduced to a minimum. All conveyors are fully programmable. The rate of feed, ramps and waiting times can be adapted to the application.

## SMEMA interface

Each conveyor has the standard SMEMA interface. Thus, machines can easily be integrated into any production lines or even combined with a loader and unloader to automate partial the dispensing process.

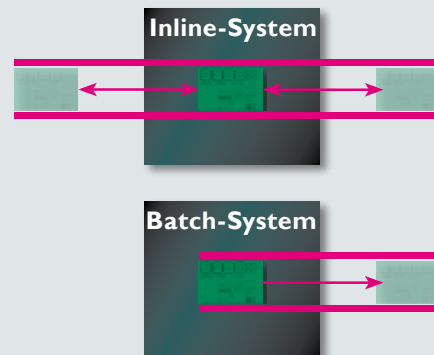
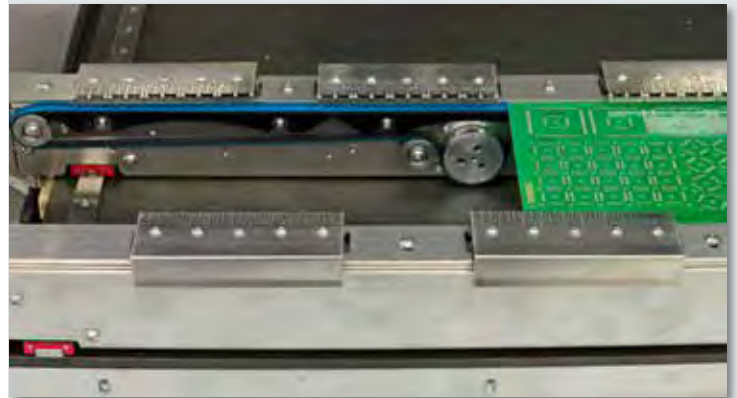

# Accessories



## Laser height sensor

This sensor is for measurement of height and can be used by the **dispenseALL420** because of very tight design. This option allows the operator a more exact and quicker measurement of reference surfaces like PCB level. A steady distance between PCB and needle tip is basis for a repeatable dispensing result. The user friendly integration in software eliminates false measurements and reduces set-up time.



## Automations Interface

The module Automation Interface enables the control of more features and options for example customized measuring instruments.



## Connection for suction

Coating with varnish or activators causes sometimes explosive fumes. A typical example are fluids based on alcohol. For a safe operation the **dispenseALL420** is equipped with a connection for suction by standard.



## Nozzle compensation

The nozzle compensation is a full-automatic sensor for adjusting the nozzle position in the Z-axis.

Advantages:

- full-automatic nozzle measurement
- reduction of set-up times
- increase of process-safety





## Media temperature control

Soldering paste, adhesive and other dispenser media change their viscosity depending on the temperature. In order to achieve constant results, the temperature of the media can be kept constant.

## Suck Back for low viscosity media

The suck back module prevents thin liquids (like oil or water) from leaking or dripping out of the syringe.

## Heating plates

Dispensing media change their viscosity at elevated temperature. The up to 200°C controllable electric heating plates are used to heat assemblies, substrates, etc.

## PCB fixture

The rapid clamping system enables an intake of one- or double sided PCBs in various forms. Therefore diverse magnetic holder freely fix and position them in the machine interior space.

- PCBs up to 580 mm x 480 mm
- Free height below the PCB: 52 mm
- Free height above the PCB: 30 mm
- One- and double-sided PCBs

## Vacuum table

For the handling of flexible PCBs a vacuum table can be integrated. There are variants for a complete vacuum suction of PCBs as well as for a partial vacuum suction. The attachment of the vacuum table is possible without the use of tools. A changing from vacuum table to the conventional PCB intake happens with the help of the grips just in a few moments.

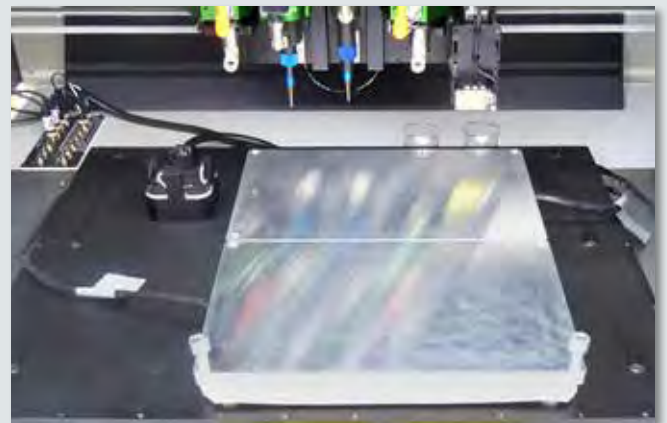

# Technical details

## Measurement system

Resolution X-Y-Axis .....0.5 µm  
Resolution Z-Axis ..... 1.6 µm

## Software

dispenseALL .....dispenseALL  
Operating system.....Windows 10

## Connectors

Electrical.....230V/110V max. 1.33 kW  
Compressed air .....6 bar, 75 psi, 0.01 micron  
Filter, max 60 L/min

Noise level .....50 - 70 dB

## General

Dispensing heads.....max. 3 heads  
Dimensions (L x W x H) .....1010 x 1020 x 1570 mm  
Weight .....ca. 450 kg  
Speed of axes .....max. 1.0 m/sec.

## Dispensing area

### Dispensing area

2 heads.....586 x 447 mm  
3 heads.....481 x 447 mm

### Min. PCB size

- stand alone.....5 x 5 mm  
- inline.....50 x 35 mm

Attention: The usable dispensing area depends on the number and configuration of the valves.

### Max. PCB size

- stand alone.....586 x 480 mm  
- inline.....450 x 400 mm  
- optional.....1000 x 400 mm

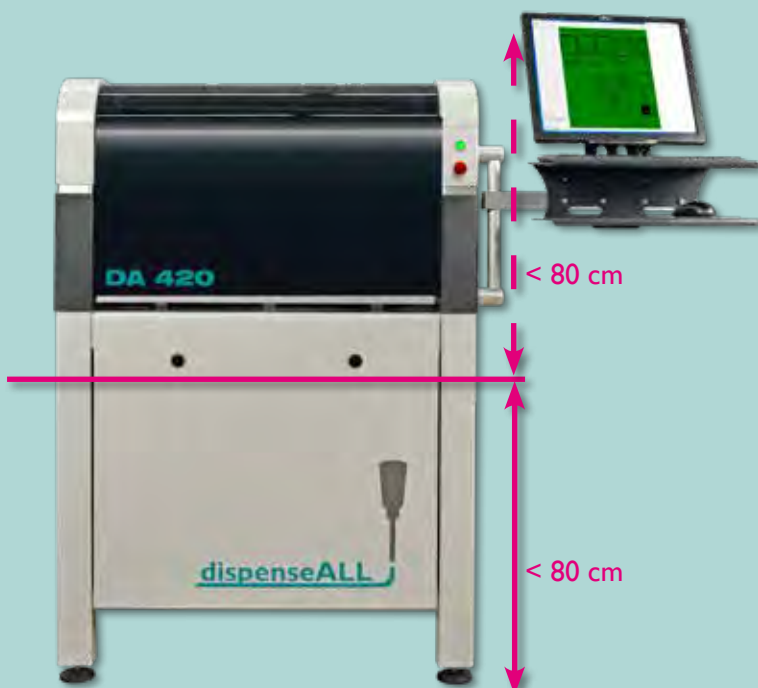

## Dividable machine frame

To pass through door frames with less than 80 cm in width, the **dispenseALL420** machine frames can be built dividable, each part being smaller than 80 cm.

# printALL

The increasing demands like finest structures and smallest components ask for new products. The solid construction of the FRITSCH stencil printers fulfill every requirement and the elaborate range enables the handling of structures up to 0,4 mm and oversized PCBs.



COMPLETE AND FULLY



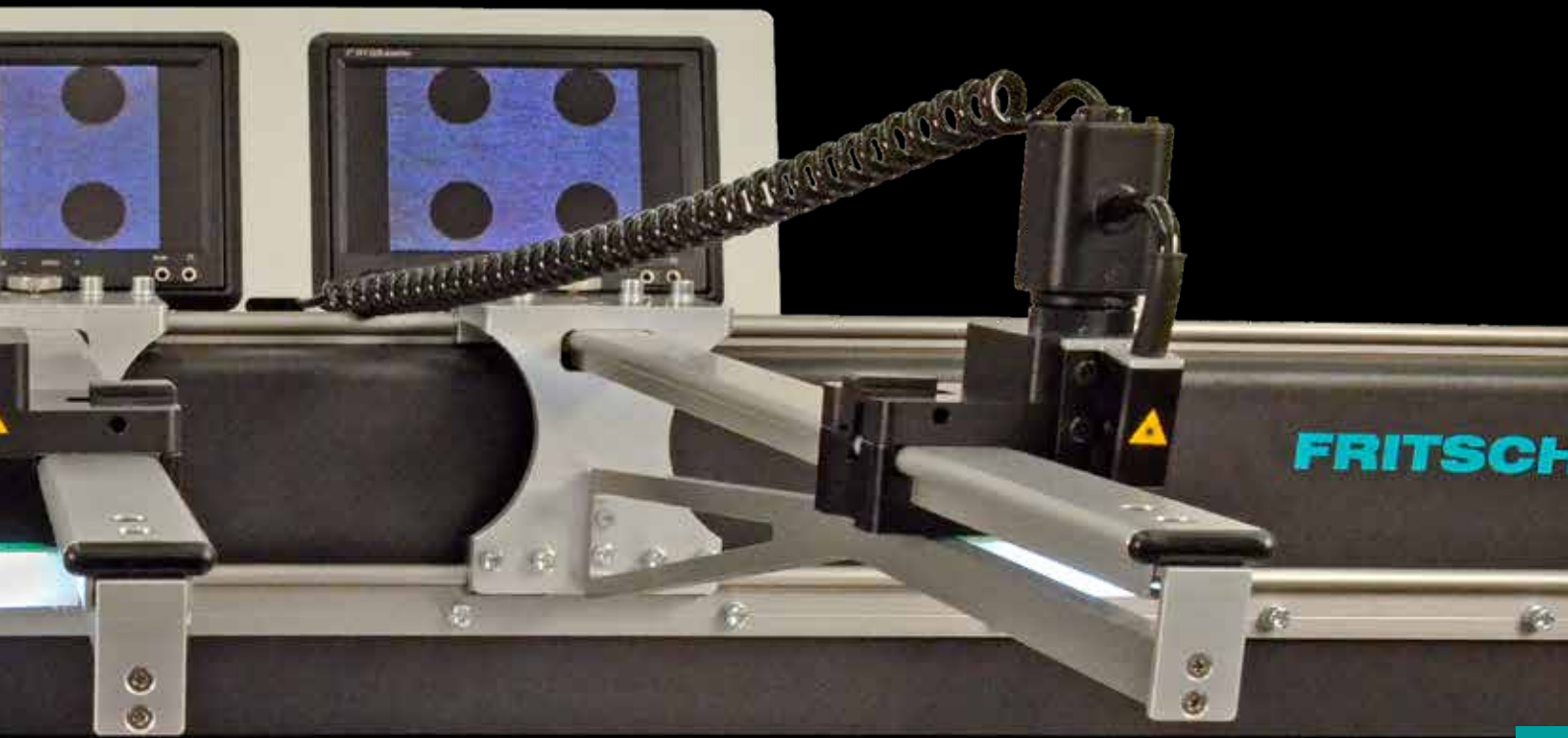



# printALL005

The **printALL005** is a manual stencil printer with a stable base frame for a high print quality. The solid construction offers an easy handling and a clean and reproducible print, even for fine structures of 0,5 mm. The printer is ideal for the production of prototypes and small series.

## Easy handling

The basic model is good to print single and double sided PCBs. For this, the PCB are placed on the base plate and mechanically fixed. The X-Y and theta axis can easily be set by using knurled screws. A parallel clearing ensures a clean separation of the PCB and stencil and guarantees a perfect print image.

## Technical Details

With stencil frame	903.203:
size of stencil:	max. 420 x 320 mm
size of PCB/effective area:	max. 380 x 280 mm
With stencil-tension-frame	903.204:
size of stencil:	max. 360 x 280 mm
size of PCB/effective area:	max. 330 x 270 mm
With mounting rail	903.205:
size of stencil:	max. 460 x 30 x 350 mm
size of PCB/effective area:	max. 390 x 290 mm
With magnetic-PCB-fixture set for double-sided printing:	
PCB bottom side:	max. 18 mm



# printALL005L

With the new **printALL005L**, larger circuit boards can now be printed. Just like its little brother, it has all the advantages of a manual stencil printer. With the optional, universal stencil clamping frame 903.208 and the squeegee guide 903.209, an even paste application can be achieved comfortably.

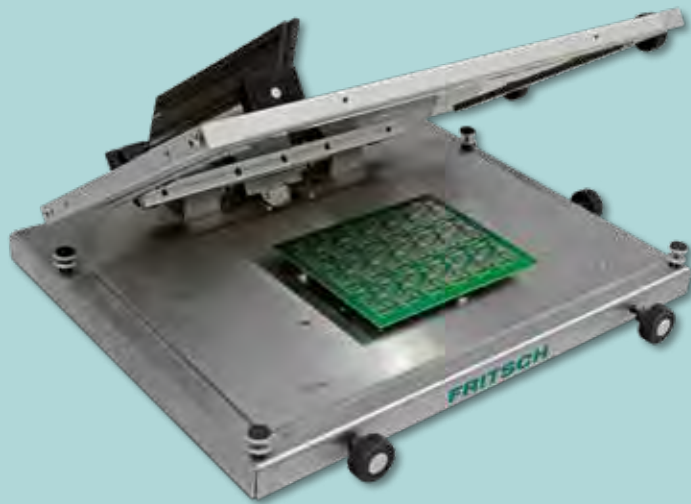

## Technical details

With the universal two side tension frame 903.208:

Stencil size:	max. 460 x 280 mm
PCB size/printing area:	max. 430 x 270 mm

With mounting rail 903.205:

Frame size:	max. 560 x 30 x 350mm
-------------	-----------------------

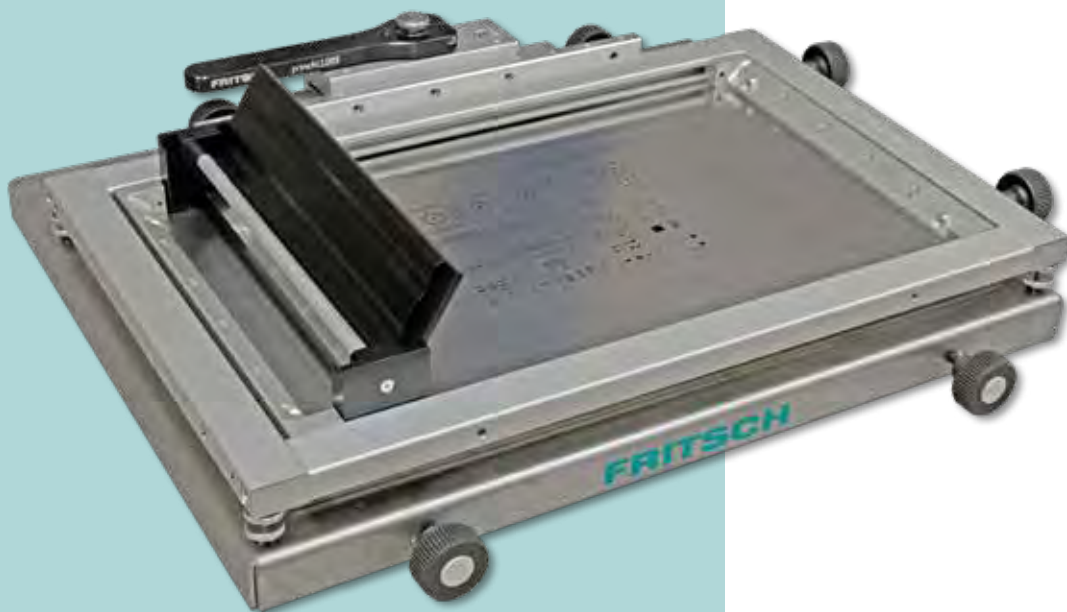





# System options

## Stencil intake

There are three variants for the intake of stencils available. For simple tasks we offer a universal frame for stencil sheets where the stencils are simply clamped without tension. (903.203).

Optimal is to use the universal stencil-tension-frame (903.204). Different sizes of stencils can be used. The tension is effected from two sides and there isn't a perforation necessary. The counterpart for the larger **printALL005L** has the order number 903.208.

A base plate for the use of fixed aluminium frames and accordingly for established Quick-Change-Systems. (903.205).

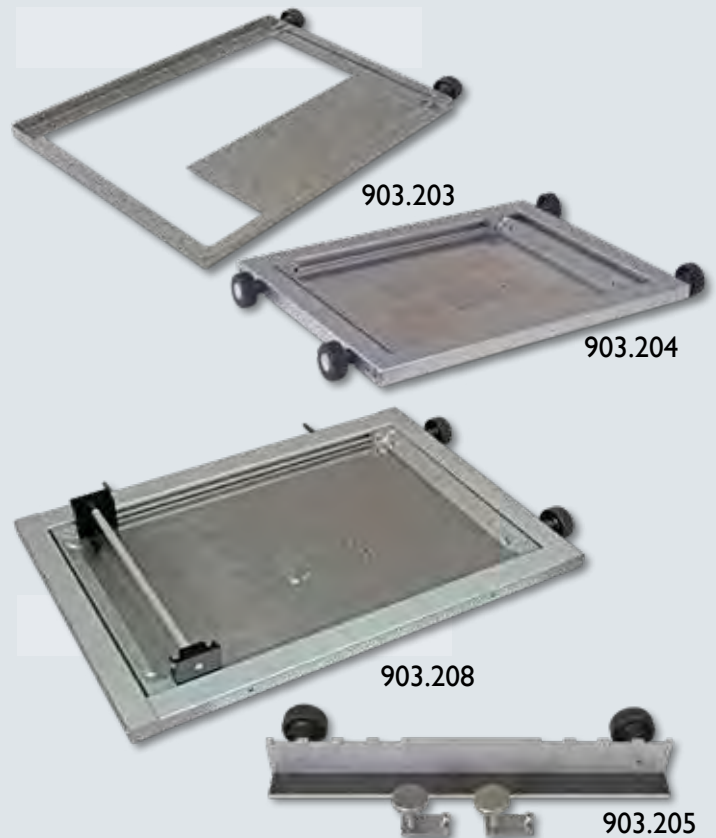

## PCB fixture

For double-sided printing the PCB has to be fixed by the magnetic fixture. (Necessary by the use of a stencil-tension-frame).

Magnetic-PCB-fixture-set Set (903.103) for double-sided printing

1 x Magnetic-PCB-support-set (903.105)

2 x Magnetic-PCB-fixture-set (903.104)

Magnetic-PCB-fixture-set (903.104) for double-sided printing / 4 x PCB-fixture

Magnetic-PCB-support-set (903.105) for double-sided printing / 4 x PCB-support

Magnetic-PCB-support (903.107) 28 x 60 mm for 903.005/L



## PCB positioning aid

The foil (903.106) facilitates the rough set up of the PCB.

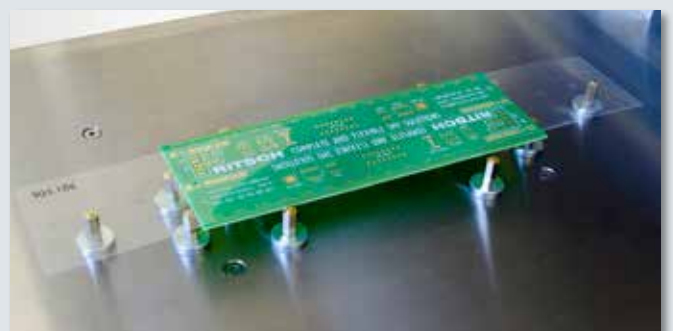

# System options



## Hand-squeegee

- SD.0037.00 Hand-squeegee 110 mm, metal
- SD.0036.00 Hand-squeegee 255 mm, metal
  
- SD.0060.00 Hand-squeegee 110 mm, metal for squeegee guide
- SD.0064.00 Hand-squeegee 205 mm, metal for squeegee guide
- SD.0061.00 Hand-squeegee 255 mm, metal for squeegee guide
  
- SD.0058.00 Hand-squeegee 110 mm, Serilor®
- SD.0059.00 Hand-squeegee 255 mm, Serilor®

## Squeegee guide

The squeegee guide is built into the universal clamping frame and is optionally available for the **printALL005/L**.

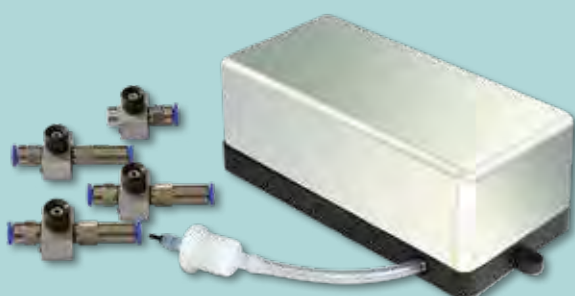

## Vacuum option

Flexible vacuum option for safe down-fixation of PCB while printing. (903.206). Incl. 4 magnetic suction cups and manual vacuum-deactivating.



The semi-automatic stencil printer with its easy handling provides clean and reproducible prints even in the case of fine structures. It is suitable for the production of prototypes as well as small and medium-sized series. The printer's stable set up is the basis for today's requirements of fulfilling the high demands of production quality. This is also safeguarded when the smallest of chips and fine structures come into use.

Conic centering pins guarantee a high repeatability and enable Fine-Pitch printing up to pitch 0.5 mm. The automatically opening and closing of the printer's top is supported by two pneumatic cylinder. Furthermore the top is fixed by two pins for correct alignment.

The semi-automatic stencil printer **printALL210L** is the continuation of the **printALL210**. Both systems are identical in solid construction and easy operation. This is the base of a clean and reproducible stencil printing and makes the handling of fine structures possible without any problems. The intake of PCBs with a size of up to 600 x 430 mm are possible at the **printALL210L**.

The semi-automatic stencil printer **printALL210XL** is the largest of the range. It was especially constructed for the handling of oversized PCBs. FRITSCH argues about a maximum PCB size up to 1240 x 600 mm.

## Visionsystem

In the case of fine structures in particular, the vision system alleviates the positioning of the stencil and thus increases the accuracy of the print. The vision system for the **printALL210** - range enables with its enormous enlargement the sharp recognition of finest structures. Both cameras have a laser positioning-help which displays the adjusted image detail.

## Vacuum table

Conditioned by the size the integration of a vacuum table is possible to guarantee a save and smooth intake of PCBs and foils. Therefore the required accuracy on oversized circuit carriers is ensured, too. The retrofit from standard intake to vacuum table and back is possible in a few minutes.

## Undertable

The **printALL** system can be used as table machine or in combination with the undertable. The undertable has by standard a storage shelf or can be equipped with a suspended register for 34 stencils. The **printALL210XL** is always fitted with the undertable.



# printALL210



## printALL210

Semi-automatic stencil printer **printALL210** for prototypes and small to medium-sized series.

Scope of delivery:

- Double squeegee for clean printing in both directions
- Standard squeegee 205 mm
- Flexible PCB fixture for one- and double-sided printing
- Parallel table lowering after printing
- Squeegee unit can be opened for easy cleaning

## Technical details

Printing area: max. 370 x 460 mm  
PCB size: max. 440 x 430 mm



## printALL210L

Semi-automatic stencil printer **printALL210L** for prototypes and small to medium-sized series.

Scope of delivery:

- Double squeegee for clean printing in both directions
- Standard squeegee 205 mm
- Flexible PCB fixture for one- and double-sided printing
- Parallel table lowering after printing
- Squeegee unit can be opened for easy cleaning

## Technical details

Printing area: max. 530 x 460 mm  
PCB size: max. 600 x 430 mm



## printALL210XL

Semi-automatic stencil printer **printALL210XL** for prototypes and small to medium-sized series.

Scope of delivery:

- Vision camera
- Motoric feed
- Pneumatic supported frame holder
- Double squeegee for clean printing in both directions
- Standard squeegee 375 mm
- Flexible PCB fixture for one- and double-sided printing
- Parallel table lowering after printing
- Squeegee unit can be opened for easy cleaning
- Under table with storage shelf

## Technical details

Printing area: max. 1170 x 630 mm  
PCB size: max. 1240 x 600 mm



## Motor-driven print

The microprocessor controller controls the lowering squeegee, controls the motor-driven squeegee feed and makes sure the print is even and reproducible. After printing, the table is automatically lowered over the pneumatic cylinder in a parallel position and the printer can be opened. All functions of the printer are handled by an optimized intuitive Touch Display. There is also the possibility to save product-specific programs. So the production can start only by choosing the accordant program.

## Table lowering

The parallel table lowering ensures clean printing results even in the case of large PCBs. A smearing of the printed layout is thus part of the past. The table with the printed circuit board is lowered automatically after printing.

## Double squeegee

The stencil printer has a double squeegee for flawless paste printing in both directions. The paste is applied within the double squeegee and is thus applicable in both directions. The contact pressure of the squeegee can be set by a screw. The squeegee angle is adjustable from 45° up to 90°.

## Maintenance and clearance

The stencil printer has a double squeegee for flawless paste printing in both directions. The paste is applied within the double squeegee and is thus applicable in both directions. The contact pressure of the squeegee can be set by a screw. The squeegee angle is adjustable from 45° up to 90°.



# System options

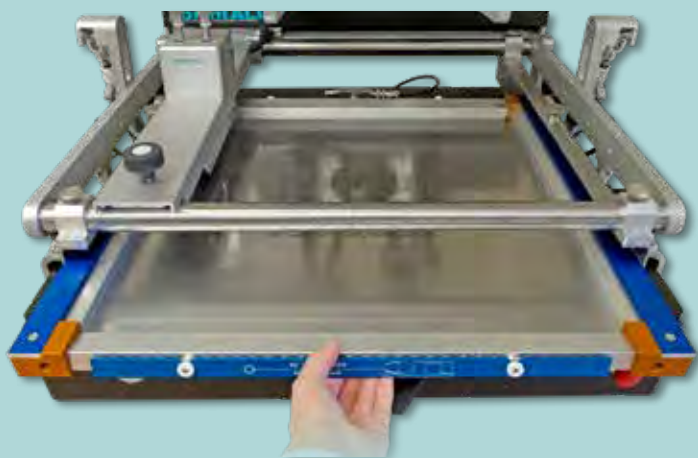

## Quick-Change-Frame

Common, sturdy aluminium frames and other usual quick change systems are used without the need for further adaptations. That enables the printing of the smallest of PCBs up to a maximum printing surface of 530 x 460 mm.

printALL210	printALL210L	printALL210XL
✓	✓	✓



## Flexible PCB fixture

The PCBs are fixed by easily adjustable magnet fixtures. The fixture can thus be adapted to a different PCB within a few seconds. The fixtures and supports included in delivery enable the one- or double-sided printing of PCBs.

printALL210	printALL210L	printALL210XL
✓	✓	✓

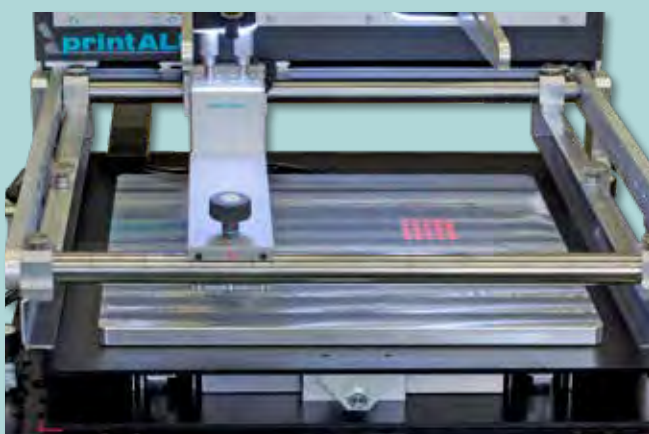

## Vacuum table

A vacuum table can be integrated for the production of flexible PCBs. It guarantees a safe fixation for foils or thin PCBs. A conversion from vacuum table to the conventional circuit board recording and vice versa is uncomplicated because it adheres to the printing table with a magnetic film.

printALL210	printALL210L	printALL210XL
✓	✓	✓





## Vision systems

- 903.210.135 Vision camera for **printALL210**  
By means of two cameras, a safe and fast alignment of the stencil is given.
- 903.210.140 Vision camera for **printALL210L**
- 903.210.142 Vision camera for **printALLXL**  
(Included in basic unit.)
- 903.210.143 Additional camera-arm with camera, object lens, lightning, and laser pointer for stencil printer **printALL210XL**



## Frame holder

- 903.210.155 Pneumatically supported frame holder for opening and closing the print frame by using a pneumatic cylinder for **printALL210/L**.



## Drawer System

- 903.210.165 Pneumatically drawer system for **printALL210**
- 903.210.166 Pneumatically drawer system for **printALL210L**



# Options

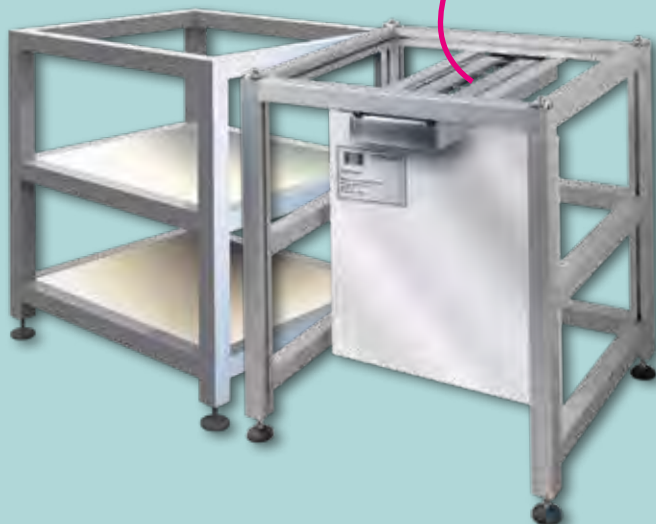
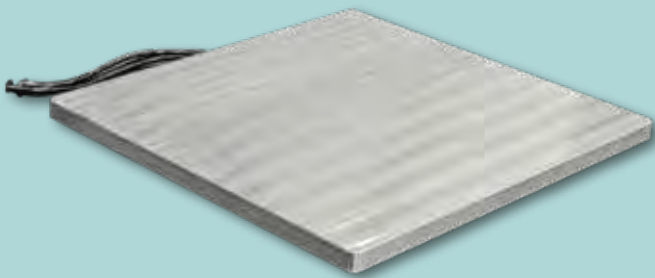

## Vacuum tables

- 903.210.130 Vacuum table for **printALL210**  
Vacuum table 450 x 450 mm for the safe intake of foils and thin PCBs.
- 903.210.131 Vacuum table for **printALL210L**  
Vacuum table 610 x 450 mm for the safe intake of foils and thin PCBs.
- On demand Vacuum table for **printALL210XL**
- 908.191.122 Vacuum pump for Vacuum table

## Vacuum option

- 903.210.151 Flexible vacuum-option for **printALL210** for safety pressing on the PCB while printing.  
4 magnetic suction cups and automatic vacuum de-activation. Only in combination with Motor-driven squeegee feed.
- 903.210.152 Flexible vacuum-option for **printALL210/L/XL** for safety pressing on the PCB while printing incl. 12 magnetic suction cups.

## Undertable

- 903.210.410 Undertable for **printALL210** with storage shelf
- 903.210.412 Undertable for **printALL210** with suspended register for 34 stencils
- 903.210.415 Undertable for **printALL210L** with storage shelf
- 903.210.416 Undertable for **printALL210L** with suspended register for 34 stencils
- SD.0046.00 Suitable holder for all packages of stencils



## Quick change system

- 903.200.210 Four-sided quick change system for stencil size 555.5 x 555.5 mm
- 903.200.250 Four-sided quick change system for stencil size 709,5 x 555,5 mm

Further systems on request.



## Test print frame

- 903.210.215 Test print frame for semi-automatic stencil printer **printALL210/L/XL**. For checking the print layout and for easy alignment for the first print incl. a test print foil 240 x 400 mm
- 903.210.216 Test print foil 240 x 400 mm



## Prototype frame

- 903.210.205 Universal prototype tension frame for stencils, for **printALL210/L**, 2-sided-tension, fixture bores aren't necessary.  
max. stencil size 360 x 280 mm  
max. PCB usable area 330 x 270 mm  
with hand squeegee 110 mm, metal and two knurled screws for fixture

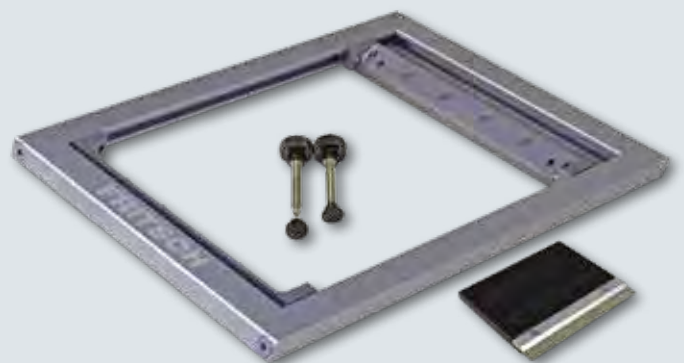



# Accessories

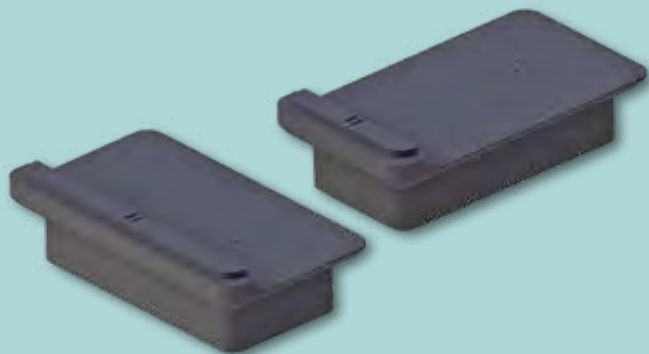

PCB support

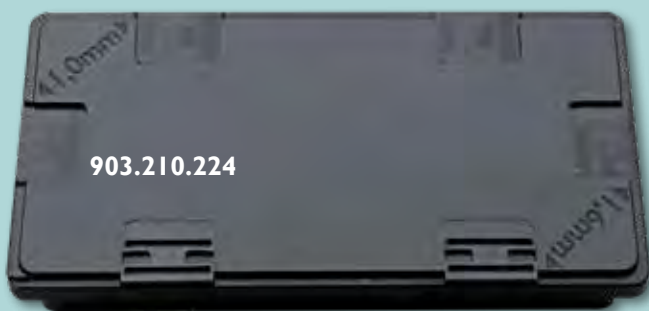

## PCB fixture

- 903.210.201 Magnetic PCB fixture slim 40 mm  
Thickness of PCB of 1.6 mm
- 903.210.202 Magnetic PCB fixture wide 70 mm  
Thickness of PCB of 1.6 mm
- 903.210.203 Magnetic PCB fixture slim 40 mm  
Thickness of PCB of 1.0 mm
- 903.210.204 Magnetic PCB fixture wide 70 mm  
Thickness of PCB of 1.0 mm
- 903.210.220 Magnetic PCB support for thickness of  
PCB of 1.6 mm
- 903.210.221 Magnetic PCB support for thickness of  
PCB of 1,0 mm
- 903.210.228 Magnetic PCB support for thickness of  
PCB of 0,8 mm
- 903.210.229 Magnetic PCB support for thickness of  
PCB of 2,0 mm
- 903.210.223 Magnetic PCB fixture small  
70 x 40 mm  
for thickness of PCB of 1.0 mm  
and 1.6 mm
- 903.210.224 Magnetic PCB fixture large  
140 x 70 mm  
for thickness of PCB of 1.0 mm  
and 1.6 mm
- 903.210.225 Magnetic PCB fixture large with fixture  
for test print foil for thickness of PCB  
of 1.0 mm and 1.6 mm
- 903.210.226 Magnetic PCB fixture small  
70 x 40 mm for thickness of PCB of  
0,8 and 2,0 mm
- 903.210.227 Magnetic PCB fixture large  
140 x 70 mm for thickness of PCB of  
0,8 and 2,0 mm
- 903.210.238 Gripper for magnetic PCB fixture large



## Metal squeegee

- 903.210.301 Holder with metal squeegee 205 mm
- 903.210.302 Holder with metal squeegee 290 mm
- 903.210.303 Holder with metal squeegee 375 mm
- 903.210.305 Holder with metal squeegee 420 mm
- 903.210.304 Holder with metal squeegee 460 mm
- 903.210.306 Holder with metal squeegee 545 mm
- 903.210.307 Holder with metal squeegee 630 mm
- 903.210.322 Surcharge for holder and metal squeegee 290 mm instead of standard 205 mm \*
- 903.210.323 Surcharge for holder and metal squeegee 375 mm instead of standard 205 mm \*
- 903.210.324 Surcharge for holder and metal squeegee 460 mm instead of standard 205 mm \*
- 903.210.325 Surcharge for holder and metal squeegee 545 mm instead of standard 205 mm \*
- 903.210.326 Surcharge for holder and metal squeegee 630 mm instead of standard 205 mm \*
- 903.210.327 Surcharge for holder and metal squeegee 420 mm instead of standard 205 mm \*

\* For double squeegee (2 pieces)

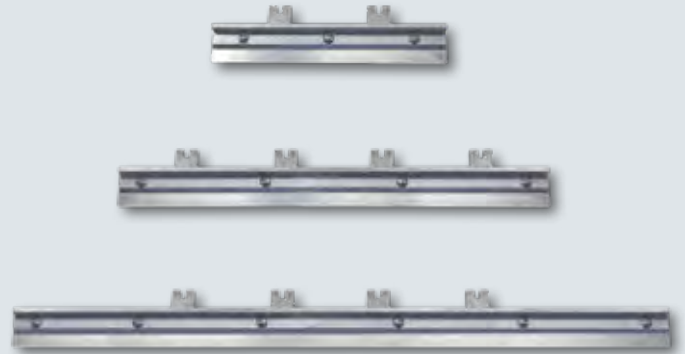

# Accessories

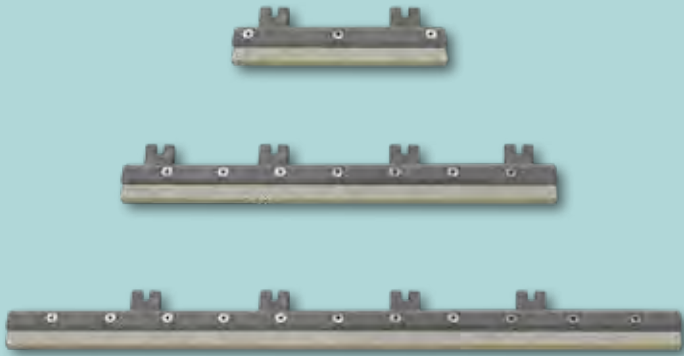

## Rubber squeegee

- 903.210.329 Holder with rubber squeegee 110 mm for screenprinting
- 903.210.330 Holder with rubber squeegee 205 mm for screenprinting
- 903.210.311 Holder with rubber squeegee 290 mm for screenprinting
- 903.210.331 Holder with rubber squeegee 375 mm for screenprinting
- 903.210.332 Holder with rubber squeegee 420 mm for screenprinting
- 903.210.312 Holder with rubber squeegee 460 mm for screenprinting
- 903.210.333 Holder with rubber squeegee 545 mm for screenprinting
- 903.210.334 Holder with rubber squeegee 630 mm for screenprinting

## Flood squeegee

- 903.210.315 Holder with flood squeegee 205 mm
- 903.210.310 Holder with flood squeegee 290 mm
- 903.210.316 Holder with flood squeegee 375 mm
- 903.210.318 Holder with flood squeegee 420 mm
- 903.210.317 Holder with flood squeegee 460 mm
- 903.210.319 Holder with flood squeegee 545 mm
- 903.210.320 Holder with flood squeegee 630 mm

## Solder pastes

- 932.114 Solder paste for stencil printing, lead-free  
S3X58-M406  
SN96.5Ag3Cu, class 4 (grain size  
20 - 38  $\mu\text{m}$ ) 11,5 % flux, tub 500 g
- 50.0184.00 Solder paste for stencil printing, lead-free  
SC BLF 04 96,5/T4  
12 % flux, tub 500 g

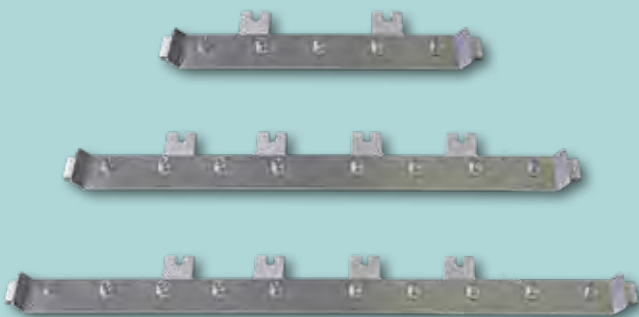



# reflow

The reflow-soldering of SMD assembled components and the curing process are easy and economic by the use of the Batch-Oven. The compact size and extremely good value of the Convection Reflow Soldering System makes Surface Mount Reflowing viable even for very small batch sizes.

# FRITSCH

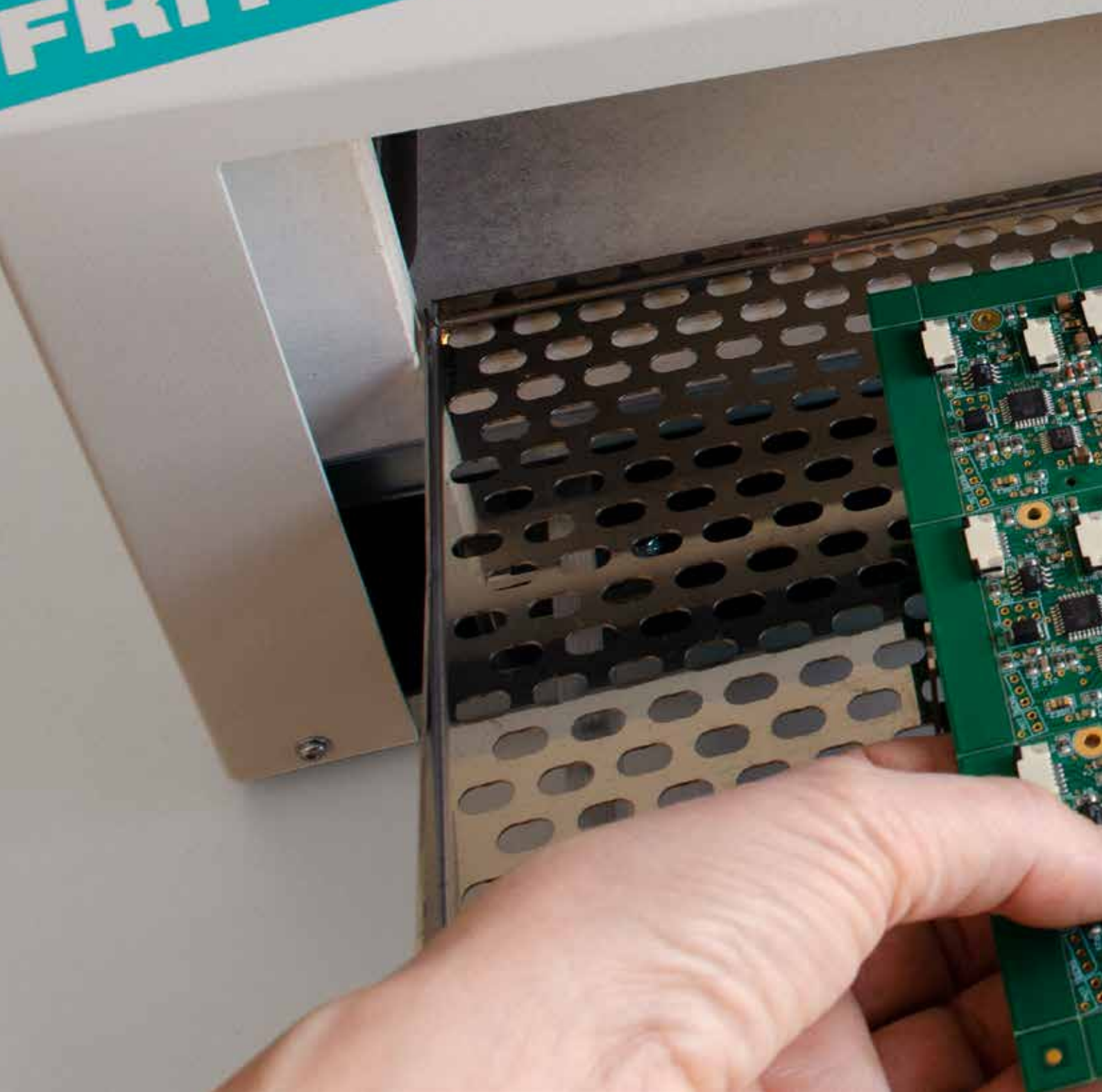



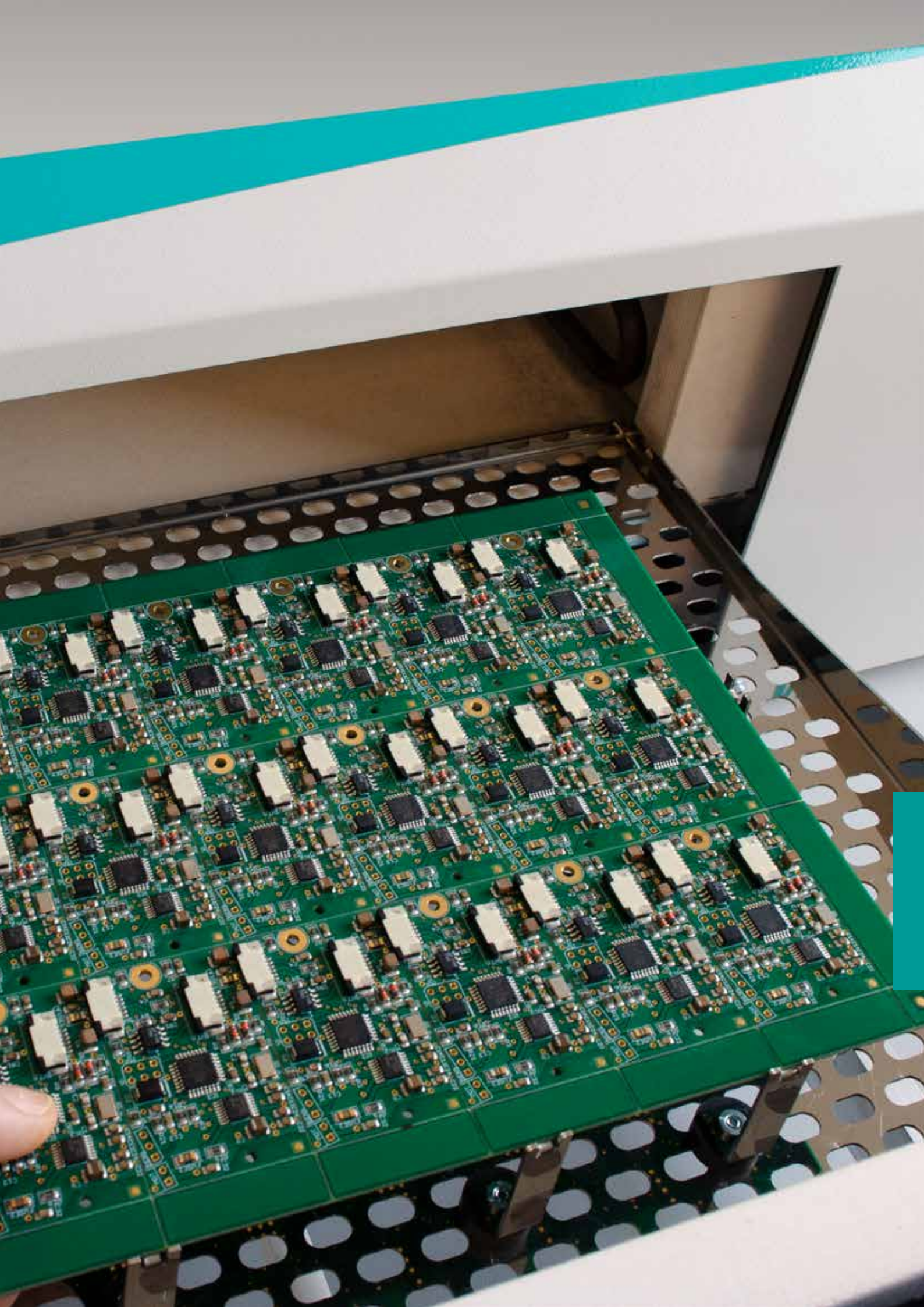





# Batch Reflow Systems

## Construction

The Convection Reflow Solder System has a drawer unit for accepting Printed Circuit Boards on individually adjustable supports which are held in place by magnetic feet. The low mass and small contact area of the supports contribute to uniform heating of PCBs. The power transmission to the component is made by convection which guarantees a fast and equal heating and avoids temperature shadows and over-heating. A further advantage of convection heating are minimal temperature differences between small and large components.

## Easy operation

Programming and operating is made by a clearly arranged keyboard. All user inputs and for the process relevant operating data are shown on the two-line LCD-Display. The menu-driven user surface enables an easy and fast handling of the system. Each temperature profile has a four digit number allocated to it which is used for storage and retrieval. As soon as the four parameters (pre-heat temperature and time and reflow temperature and time) for a heating cycle are defined, the process can be started.

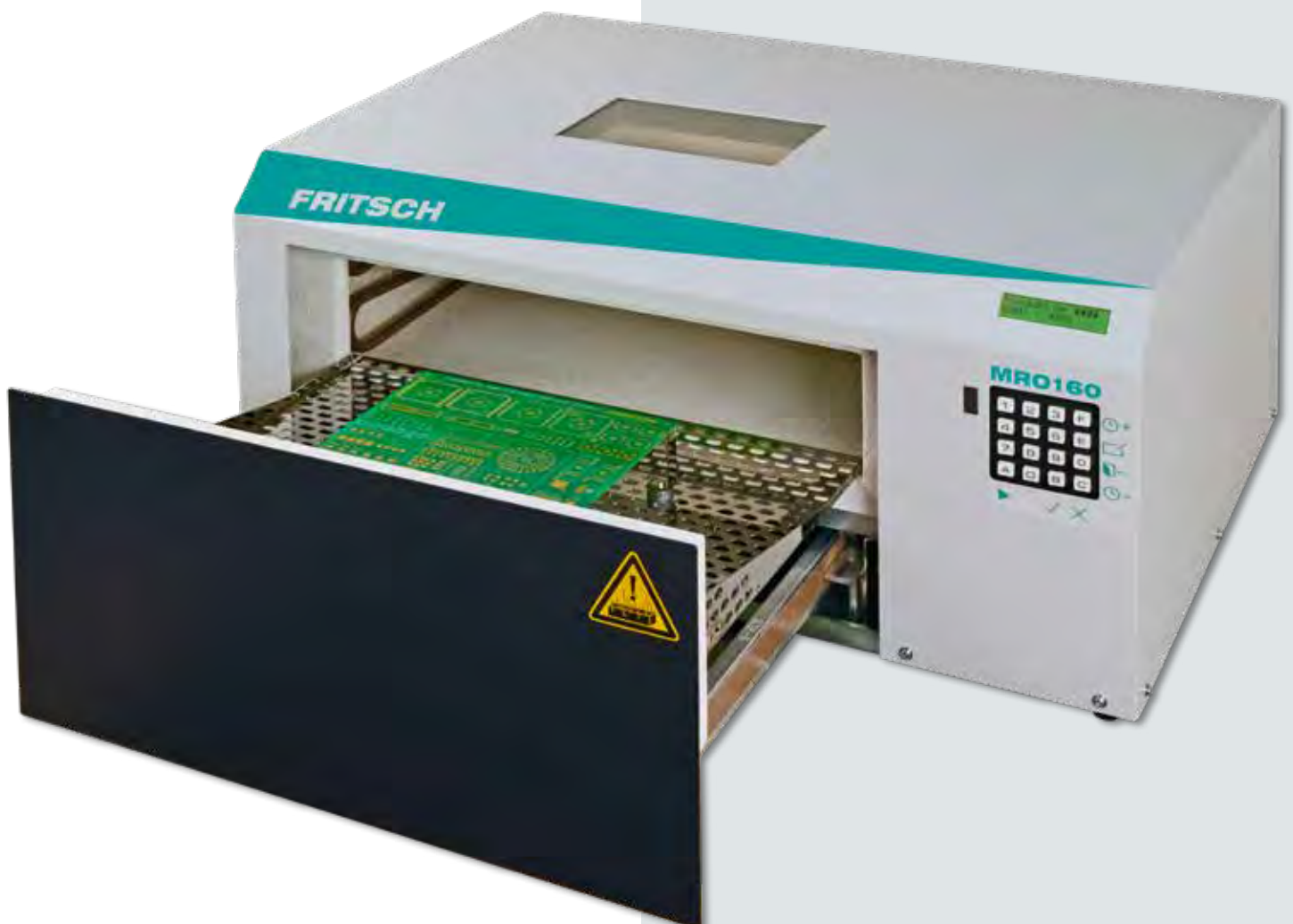



# Batch Reflow Systems

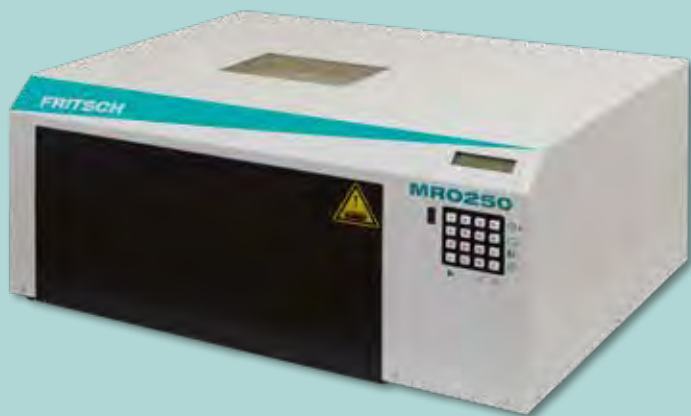

## Batch Reflow System 160

Convection Reflow Solder System.

Batch system with microprocessor control, for the laboratory and small series.

### Technical details

Dimensions:	480 mm x 260 mm x 230 mm
Weight:	18 kg
Voltage:	230 V/50 Hz
Output power:	2,2 kW
Max. PCB size:	200 mm x 160 mm

## Batch Reflow System 250

Convection Reflow Solder System.

Batch system with microprocessor control, for the laboratory and small series.

### Technical details

Dimensions:	590 mm x 260 mm x 230 mm
Weight:	21 kg
Voltage:	230 V/50 Hz
Output power:	3,5 kW
Max. PCB size:	350 mm x 250 mm

### The following datas are for all types of Batch Reflow Systems.

Preheating-temperature/time:	50 - 240°C, 1 - 3600 s
Reflow-temperature/time:	75 - 300°C, 1 - 180 s
Longterm process	50 - 220°C, 1 - 1440 min
Temperature stabilisation:	5 min
Temperature rise:	ca. 0,9°C/s

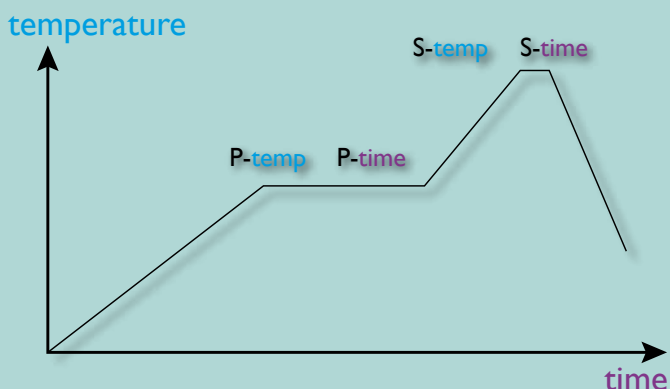



## Software

The optional user interface under Windows facilitates the remote control of the oven programme and, at the same time, the recording of the temperature profiles (an additional measuring channel is optionally available). The temperature profile can easily be programmed on the screen. In doing so, any number of process steps with temperature and time can be displayed (heat zone simulation). A connection between the PC and the Reflow Soldering System is set up via the serial interface. The internal microcontroller takes over the entire control of the heating process and guarantees reliable and reproducible results. The programming and operation takes place with the help of the user interface. All user input and the operating data that is essential for the process is displayed. The temperature profile in the heating chamber is displayed as a diagram and can be stored and printed. In order to record another temperature (e.g. on a component), an additional thermocouple (NiCrNi) is connected. This temperature profile is likewise displayed in the diagram.

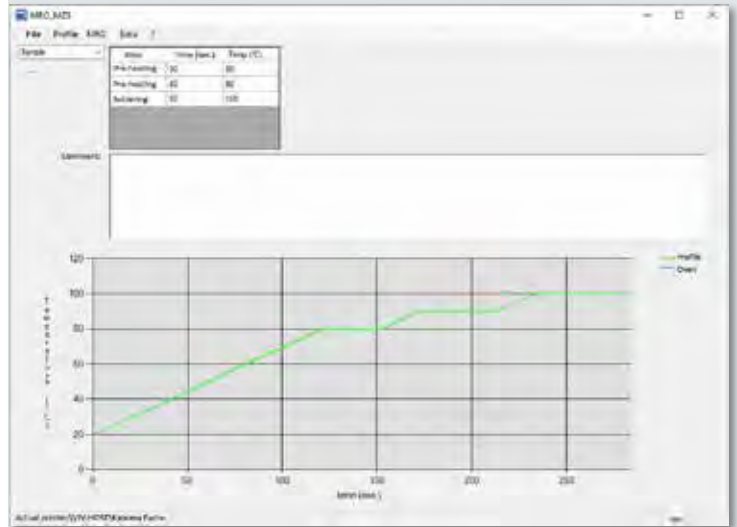

## Flexible

While a heating cycle is in progress the set heating time can be altered as required. Any new value will be stored automatically in the profile memory location.

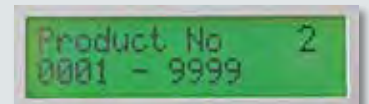
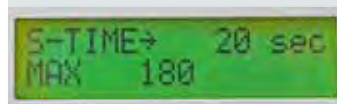

## Comfortable

At the end of the heating cycle the drawer opens automatically to allow the PCB to cool.

## Economics

The Reflow Soldering of SMD assembled components as well as the hardening of glue by the Batch Oven is easy and economical.

The compact size and extremely good value are further advantages of these convection Reflow Solder Systems.



# Options



## Extension software

903.252 Control and protocol software for the 903.160 and 903.250 Soldering Systems (Windows 2000, XP, Vista, Windows 7)

Batch Reflow System 160	Batch Reflow System 250
✓	✓

## PCB holder

903.255 PCB holder for Batch Reflow Solder Systems

Batch Reflow System 160	Batch Reflow System 250
✓	✓

## Extension measuring channel

Extension to the Reflow Soldering Systems 903.160 and 903.250 with 2nd measuring channel for recording the temperature directly on the PCB or on a component.

903.251 Extension 2nd measuring channel

Batch Reflow System 160	Batch Reflow System 250
✓	✓

## Cover gas operation

903.253 Option cover gas N2 operation

Batch Reflow System 160	Batch Reflow System 250
✓	✓

903.254 Option azotic-controlling with bypass and door seal (only in combination with 903.253)

Batch Reflow System 160	Batch Reflow System 250
✓	✓

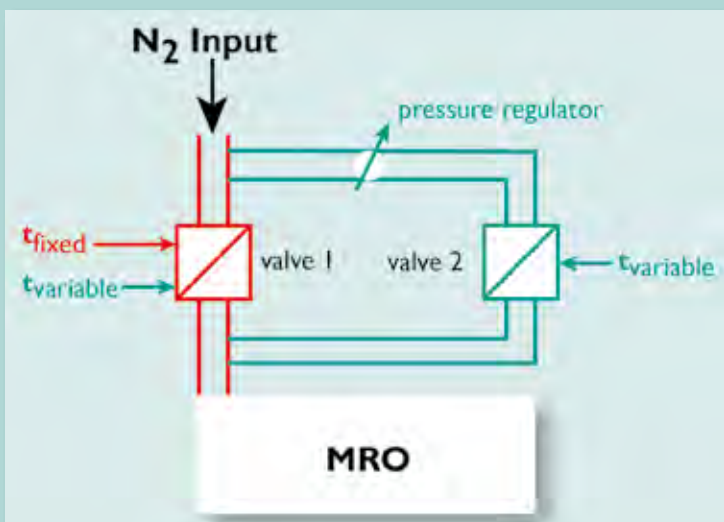





# Inline Reflow Systems

## Reflow Soldering Oven

The reflow ovens guarantee an environment-friendly lead-free soldering of highest component diversity incl. QFP, BGA/ CSP etc. Small and medium series are the optimal application for the oven.

The basic machine disposes of a heating chamber with eight heating zones, in each case four on the top and bottom. The heating zones emit convective heat with the help of hot air blower. The upper part of the heating chamber includes additional a cooling zone and an exhaust air bonnet in the lead-in and lead-out-area. A pin chain transports the soldering manor. The soldering system is handled by a modern 7" touch panel. An one-channel temperature sensor is integrated for controlling the contour of soldering on the PCB. An equal thermoelement sensor is in the scope of delivery.



## Technical details

The Inline Soldering System has 8 heating zones - 4 up and 4 down, one cooling zone and 2 suction hoods.

Dimensions:	2010 mm x 790 mm x 1440 mm, closed
Weight:	ca. 280 kg
Length of active chamber:	850 mm
Infeed height:	ca. 45 mm
Usable working width pin chain:	35 - 395 mm
Speed of transport:	15 cm/min – 90 cm/min
Heating-up power:	max. 11 kW
Max. Reflow temperature:	ca. 280°C
Suction socket:	connection Ø 60 mm
Needed exhaust air volume:	270 m <sup>3</sup> /h
Connection value:	16 A, 400V/50 Hz 3 P + N + PE, CEE connector
Operation:	7" Touchpanel

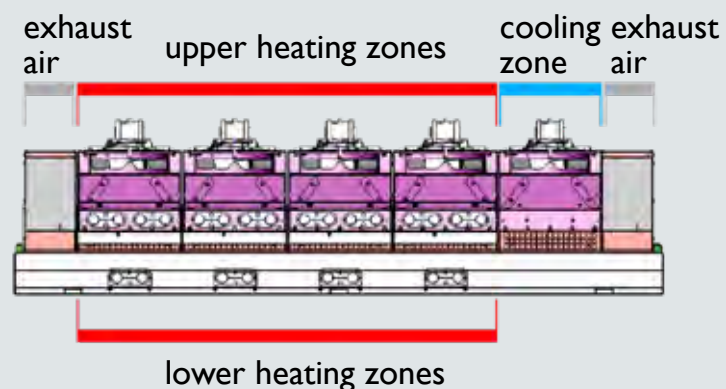

# Features, options



## Base cabinet

The included cabinet at the basic machine enables the safe placement of the Soldering System as stand-alone or inline variant of a production line. The base cabinet offers also a lot of storage space for the needed equipment.

## Signal light

The system display informs about all values of the system. These are the operating status, error reports, the nominal and actual temperature of all heating areas, the actual temperature of the intern temperature profiler and the transport speed.

## Power Save Package

As soon as the function Power Save Package is activated after a fixed period in no-load operation the system is stand-by. The system is automatically cooled down to a defined temperature.

## SMEMA

The oven has a standardized SMEMA interface and can thus be integrated into existing production lines.

## Pin Chain Transfer

The optional pin chain enables the handling of double sided assembled PCBs. With the integrated hand crank the wanted working width can be adjusted. PCBs with a width of up to 395 mm can be soldered without any problems.

## Exhaust air box

Glue and soldering fumes which result from operating are permanently unhealthy. To protect the room air for upheated and eventual with flux fume contaminated exhaust air a box can be installed at the backside of the soldering system.

# References

For more than 40 years we are specialized on all issues relating to Surface Mounting Technology. We realized with our customers several projects and their names guarantee our Know-how.



BZM electronics



Driesen+Kern GmbH



Hochschule für angewandte Wissenschaften Würzburg-Schweinfurt

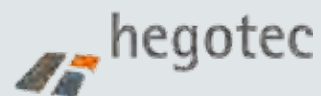





Ingenieurbüro  
V. Reuther



SHORTCUT SOLUTIONS



Fritsch GmbH • Kastnerstraße 8 • D-92224 Amberg  
Tel: +49 9621 78800-0 Fax: +49 9621 78800-49  
[www.fritsch-smt.de](http://www.fritsch-smt.de)