

Products for the electronic industry

Supplementary catalogue of the Preci-Dip program

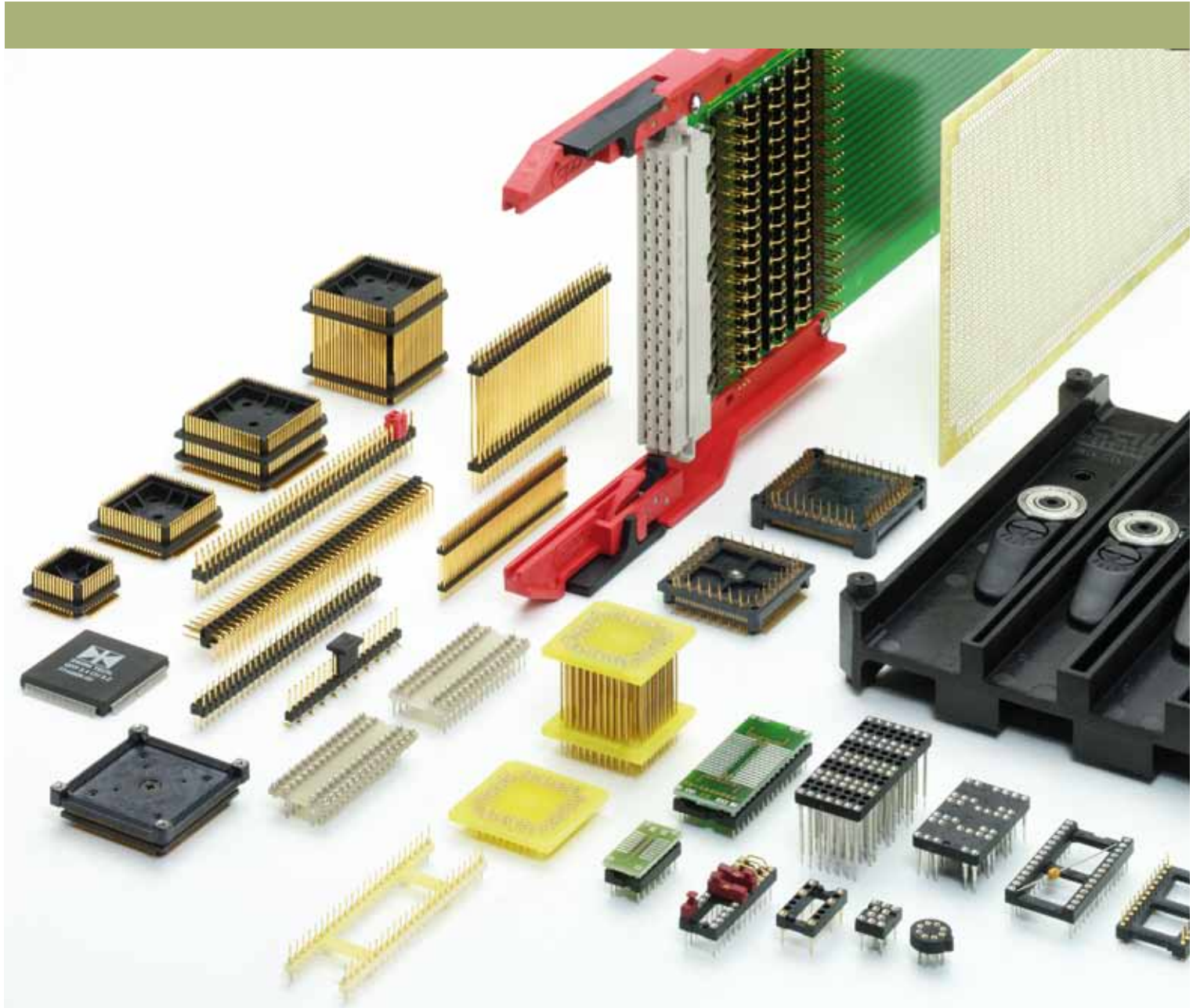

PCB Connectors Special sockets and accessories

Edition 5.1

cab - The safe contact **Supplementary catalogue of the Preci-Dip programm**



For over 30 years now **cab** in Karlsruhe is your partner for IC-sockets and connectors with precision contacts. Thanks to the biggest store in Germany we can respond immediately to your requirements. We also manufacture in small quantities according to individual customers requirements.

Please find the latest news at www.cab.de



preci-dip

Preci-Dip in Delémont / Switzerland is the worlds leading producer of precision contacts for IC-sockets, pin strips and socket boards. With 250 employees Preci-Dip produces more than 150 million pieces per week. Within the broad range of precision contacts be sure to find the right solution for your requirements.

Please find further information at www.precidip.com

TET

TET in Tokio / Japan develops and manufactures mainly QFP- and BGA-sockets and adapters for the laboratory and test range. We can help you fast and efficiently during your developmental period.

Please find further information at www.tetc.co.jp

3 Contents

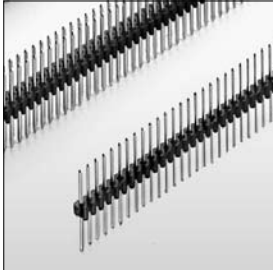

6

Pin Connectors Pitch 1.27 mm
Pin Ø 0.48 mm
single row / double row

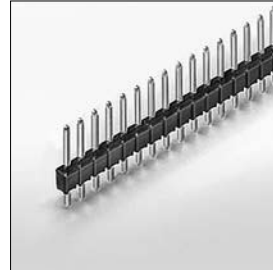

12

Pin Connectors Pitch 2.54 mm
Pin ∇ 0.635 mm
single row

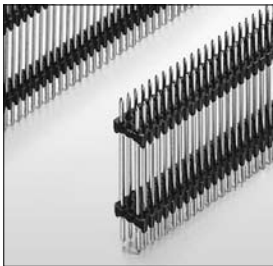

7

Pin Connectors Pitch 1.27 mm
Pin Ø 0.48 mm
single row / double row Sandwich

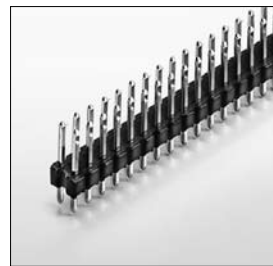

13

Pin Connectors Pitch 2.54 mm
Pin ∇ 0.635 mm
double row

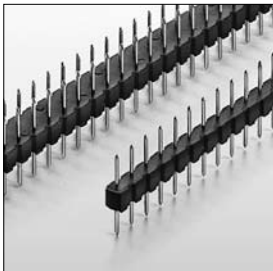

8

Pin Connectors Pitch 2.54 mm
Pin Ø 0.48 mm
single row / double row

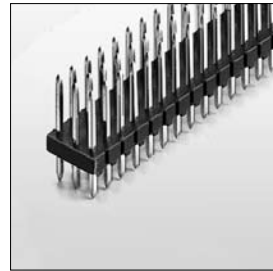

16

Pin Connectors Pitch 2.54 mm
Pin ∇ 0.635 mm
triple row

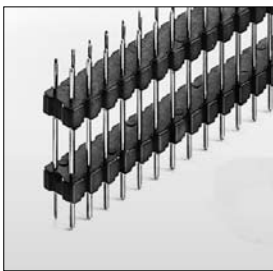

9

Pin Connectors Pitch 2.54 mm
Pin Ø 0.48 mm
single row / double row Sandwich

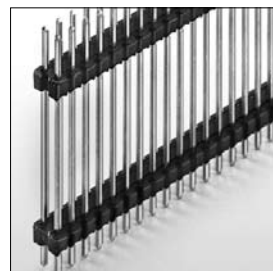

14

Pin Connectors Pitch 2.54 mm
Pin ∇ 0.635 mm
single row / double row Sandwich

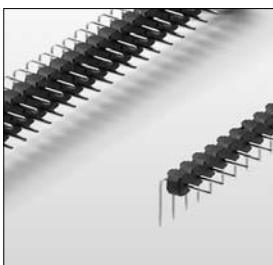

10

Pin Connectors Pitch 2.54 mm
Pin Ø 0.48 mm
single row / double row right angle



15

Pin Connectors Pitch 2.54 mm
Pin ∇ 0.635 mm
single row / double row right angle

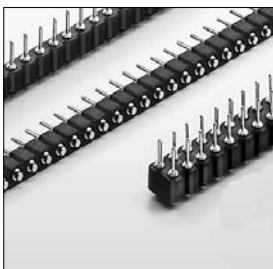

11

SMD Pin Connectors Pitch 2.54 mm
Pin Ø 0.48 mm
single row / double row



16

Pin Connectors Pitch 2.54 mm
Pin ∇ 0.635 mm
triple row right angle

4 Contents

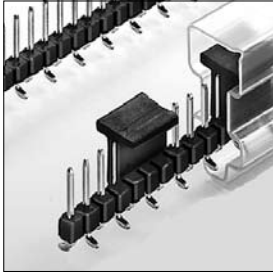

17
SMD Pin Connector Pitch 2.54 mm
Pin \square 0.635 mm
single row / double row

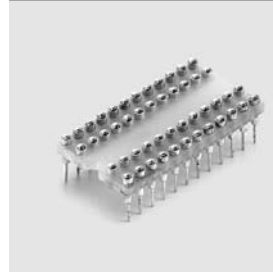

22
DIL -> DIL Reduction Sockets

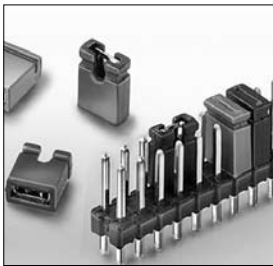

18
Female Jumpers
Pitch 2.54 mm
for square Pins

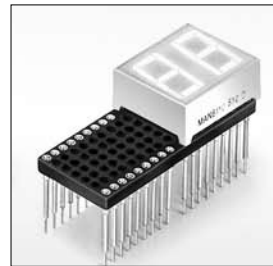

23
LED Sockets

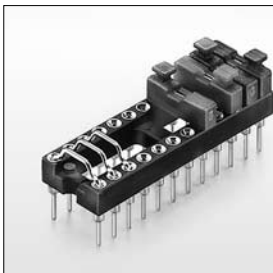

19
Male Jumpers
Pitch 2.54 / 5.08 / 7.62 mm



24
DIL Sockets partial assembled

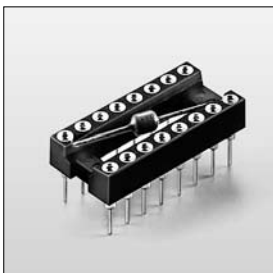

20
DIL Sockets with Capacitor

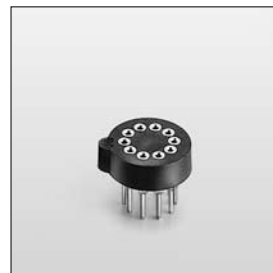

24
TO Sockets

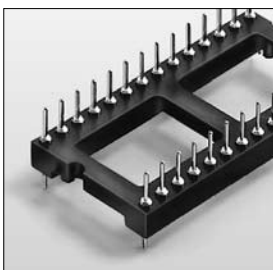

21
DIL Sockets with Pin Contacts SMD

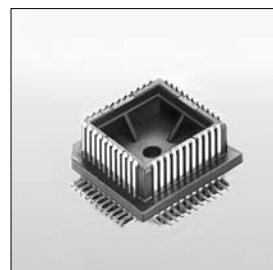

25
PLCC-Adapter Series 531

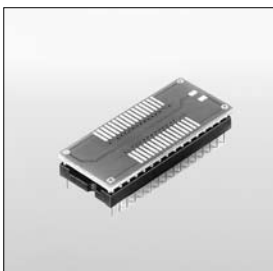

22
DIL -> SOP Converter Sockets

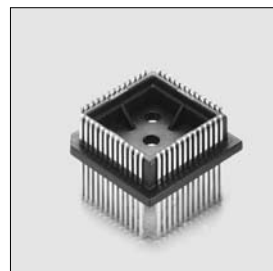

26
PLCC-Adapter Series 532

5 Contents

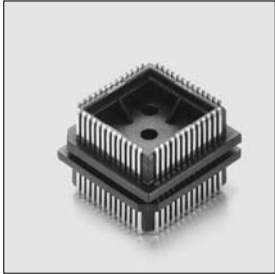

27

PLCC-Adapter Series 533

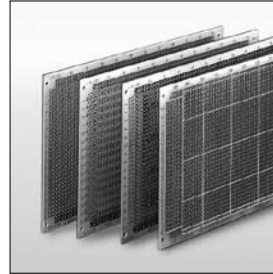

33

19" Laboratory cards

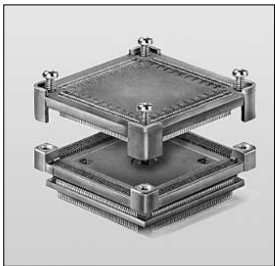

28

QFP Sockets

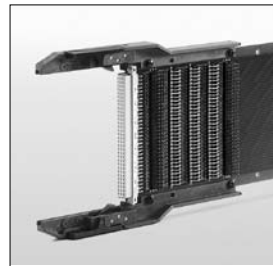

34

19" Extender boards

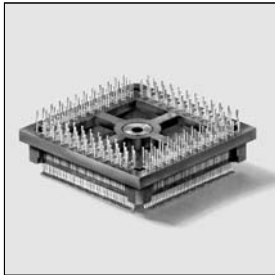

29

**QFP Solder Base
Series Q1001**



35

Tools

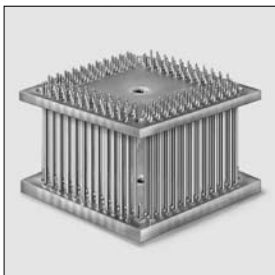

30

**QFP Extender
Series Q1501/Q1502**

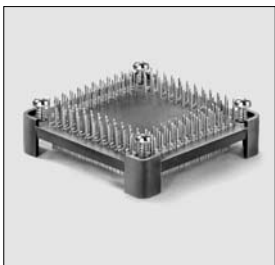

31

**QFP-Adapter
Serie Q2201**

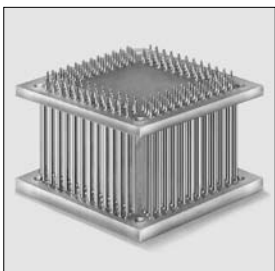

32

**QFP-Extender
Serie Q2101/Q2102**

6 Pin Connector Pitch 1.27 mm Round Pin Ø 0.48 mm



Material typical CuZn alloy
Surface 2-3 µm nickel, 0,15 µm gold
Insulator body Thermopl. polyester glass-fibre reinforced, UL 94V0
Operation temper. -55 up to 125 °C
Solder temperature from 235°C acc. IEC 68-2-54 Ta
Solder heat resist. up to 260°C 5 sec. acc. IEC 68-2-20 Tb
Rated voltage 100 V_{RMS} / 150 VDC
Insulation resistance > 10¹⁰ Ω
Air and creepage distance > 0.7 mm
Moisture sensibility level (MSL) J-STD-020C Level 1

	Pin No.	A	B	C	Pins	0.15 µm gold
Series 2101 	12	9.2	4.7	3.0	64	2101-121-064 Pins
Series 2102 	12	9.2	4.7	3.0	128	2102-121-128 Pins
Series 6102 	12	9.2	4.7	3.0	128	6102-121-128 Pins

We deliver the pins in every required number of poles. The insulator can be positioned in every place.

The pin lengths stated in the chart below with 0.15 µm gold plating are stock articles.

We manufacture more pin lengths order related from 60,000 pins.

Single contact pin stock items

A	Gold 0,15 µm		
9.2	x		
10.2	x		
11.4	x		
12.4	x		
13.5	x		
15.2	x		
16.5	x		
17.5	x		
18.6	x		
20.3	x		
23.5	x		

Checklist

Series 2101 2102 6102

Pin length A _____ B + C + 1.5 mm
 B _____
 C _____

Surface gold plated 0.15 µm
 gold plated 0.75 µm

Amount of Pins _____

Demand _____ pieces

7 Pin Connector Pitch 1.27 mm Round Pin Ø 0.48 mm

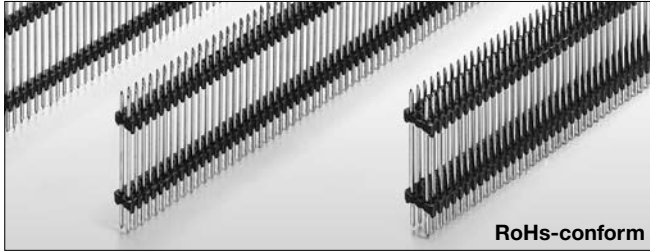

Material typical CuZn alloy
Surface 2-3 µm nickel, 0,15 µm gold
Insulator body Thermopl. polyester glass-fibre reinforced, UL 94V0
Operation temper. -55 up to 125 °C
Solder temperature from 235°C acc. IEC 68-2-54 Ta
Solder heat resist. up to 260°C 5 sec. acc. IEC 68-2-20 Tb
Rated voltage 100 V_{RMS} / 150 VDC
Insulation resistance > 10¹⁰ Ω
Air and creepage distance > 0.7 mm
Moisture sensibility level (MSL) J-STD-020C Level 1

	Pin No.	A	B	C	D	Pins	0.15 µm gold
Series 2104 	19	17.5	3.0	3.0	11.5	64	2104-191-064 Pins
Series 2105 	19	17.5	3.0	3.0	11.5	128	2105-191-128 Pins
Series 6105 	19	17.5	3.0	3.0	11.5	128	6105-191-128 Pins

We deliver the pins in every required number of poles. The insulator can be positioned in every place.

The pin lengths stated in the chart below with 0.15 µm gold plating are stock articles.

We manufacture more pin lengths order related from 60,000 pins.

Single contact pin stock items

A	Gold 0.15 µm		
9.2	x		
10.2	x		
11.4	x		
12.4	x		
13.5	x		
15.2	x		
16.5	x		
17.5	x		
18.6	x		
20.3	x		
23.5	x		

Checklist

Series 2104 2105 6105
Pin length A _____ B + C + D mm
 B _____
 C _____
Surface gold plated 0.15 µm
 gold plated 0.75 µm
Amount of pins _____
Demand _____ pieces

8 Pin Connector Pitch 2.54 mm Round Pin Ø 0.48 mm

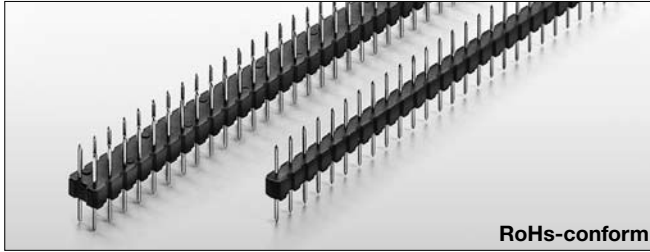

Material typical CuZn alloy
Surface 2-3 µm nickel, 0,15 µm gold
Insulator body Thermopl. polyester glass-fibre reinforced, UL 94V0
Operation temper. -55 up to 125 °C
Solder temperature from 235°C acc. IEC 68-2-54 Ta
Solder heat resist. up to 260°C 10 sec. acc. IEC 68-2-20 Tb
Rated voltage 100 V_{RMS} / 150 VDC
Insulation resistance > 10¹⁰ Ω
Air and creepage distance > 2,0 mm
Moisture sensibility level (MSL) J-STD-020C Level 1

Series 1101

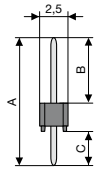
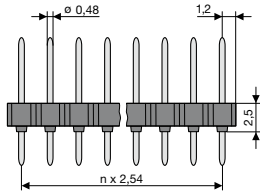

Pin No.	A	B	C	Pins	0.15 µm gold
12	9.2	3.7	3.0	32	1101-121-032
13	10.2	4.7	3.0	32	1101-131-032
14	11.4	5.7	3.2	32	1101-141-032
15	12.4	6.7	3.2	32	1101-151-032
16	13.5	7.7	3.3	32	1101-161-032
17	15.2	9.7	3.0	32	1101-171-032
18	16.5	10.7	3.3	32	1101-181-032
19	17.5	11.7	3.3	32	1101-191-032
20	18.6	12.7	3.4	32	1101-201-032
21	20.3	14.7	3.1	32	1101-211-032
22	23.5	17.7	3.3	32	1101-221-032

Pins

Series 1102

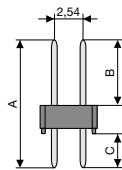
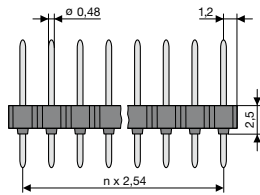

12	9.2	3.7	3.0	64	1102-121-064
13	10.2	4.7	3.0	64	1102-131-064
14	11.4	5.7	3.2	64	1102-141-064
15	12.4	6.7	3.2	64	1102-151-064
16	13.5	7.7	3.3	64	1102-161-064
17	15.2	9.7	3.0	64	1102-171-064
18	16.5	10.7	3.3	64	1102-181-064
19	17.5	11.7	3.3	64	1102-191-064
20	18.6	12.7	3.4	64	1102-201-064
21	20.3	14.7	3.1	64	1102-211-064
22	23.5	17.7	3.3	64	1102-221-064

Pins

We deliver the pins in every required number of poles. The insulator can be positioned in every place.

The pin lengths stated in the chart below with 0.15 µm gold plating are stock articles.

We manufacture more pin lengths order related from 60,000 pins.

Single contact pin stock items

A	Gold 0.15 µm		
9.2	x		
10.2	x		
11.4	x		
12.4	x		
13.5	x		
15.2	x		
16.5	x		
17.5	x		
18.6	x		
20.3	x		
23.5	x		

Checklist

Series	<input type="checkbox"/> 1101	<input type="checkbox"/> 1102
Pin length	A _____ B + C + 2.5 mm _____ B C _____	
Surface	<input type="checkbox"/> Tin plated <input type="checkbox"/> gold plated 0.15 µm <input type="checkbox"/> gold plated 0.75 µm	
Amount of pins	_____	
Demand	_____ pieces	

9 Pin Connector Pitch 2.54 mm Round Pin Ø 0.48 mm



Material typical CuZn alloy
Surface 2-3 µm nickel, 0,15 µm gold
Insulator body Thermopl. polyester glass-fibre reinforced, UL 94V0
Operation temper. -55 up to 125 °C
Solder temperature from 235°C acc. IEC 68-2-54 Ta
Solder heat resist. up to 260°C 10 sec. acc. IEC 68-2-20 Tb
Rated voltage 100 V_{RMS} / 150 VDC
Insulation resistance > 10¹⁰ Ω
Air and creepage distance > 2.0 mm
Moisture sensibility level (MSL) J-STD-020C Level 1

Series 1104

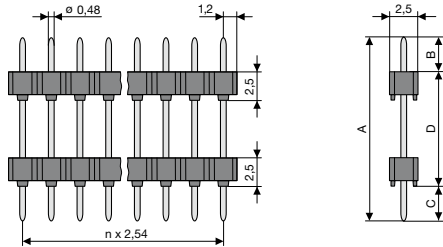

Pin No.	A	B	C	D	Pins	0.15 µm gold
15	12.4	3.7	3.2	5.5	32	1104-151-032
16	13.5	3.7	3.2	6.5	32	1104-161-032
17	15.2	3.7	3.0	8.5	32	1104-171-032
18	16.5	3.7	3.3	9.5	32	1104-181-032
19	17.5	3.7	3.3	10.5	32	1104-191-032
20	18.6	3.7	3.4	11.5	32	1104-201-032
21	20.3	3.7	3.1	13.5	32	1104-211-032

Series 1105

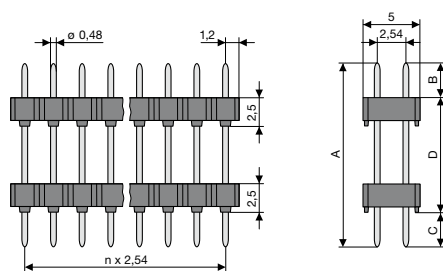

15	12.4	3.7	3.2	5.5	64	1105-151-064
16	13.5	3.7	3.2	6.5	64	1105-161-064
17	15.2	3.7	3.0	8.5	64	1105-171-064
18	16.5	3.7	3.3	9.5	64	1105-181-064
19	17.5	3.7	3.3	10.5	64	1105-191-064
20	18.6	3.7	3.4	11.5	64	1105-201-064
21	20.3	3.7	3.1	13.5	64	1105-211-064

We deliver the pins in every required number of poles. The insulator can be positioned in every place.

The pin lengths stated in the chart below with 0.15 µm gold plating are stock articles.

We manufacture more pin lengths order related from 60,000 pins.

Single contact pin stock items

A	Gold 0.15 µm		
9.2	x		
10.2	x		
11.4	x		
12.4	x		
13.5	x		
15.2	x		
16.5	x		
17.5	x		
18.6	x		
20.3	x		
23.5	x		

Checklist

Series 1104 1105
Pin length A _____ B + C + D mm
 B _____
 C _____
 D _____
Surface tin plated
 gold plated 0.15 µm
 gold plated 0.75 µm
Amount of pins _____
Demand _____ pieces

10 Pin Connector Pitch 2.54 mm Round Pin Ø 0.48 mm

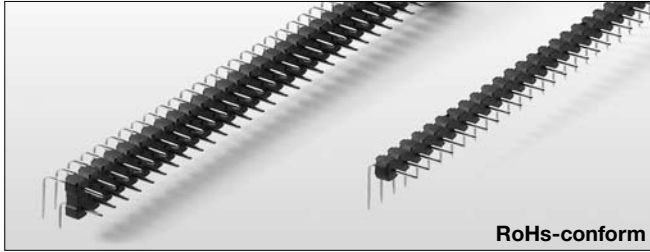

Material typical CuZn alloy
Surface 2-3 µm nickel, 5 µm tin, 0,15 µm gold
Insulator body Thermopl. polyester glass-fibre reinforced, UL 94V0
Operation temper. -55 up to 125 °C
Solder temperature from 235°C acc. IEC 68-2-54 Ta
Solder heat resist. up to 260°C 10 sec. acc. IEC 68-2-20 Tb
Rated voltage 100 V_{RMS} / 150 VDC
Insulation resistance > 10¹⁰ Ω
Air and creepage distance > 2.0 mm
Moisture sensibility level (MSL) J-STD-020C Level 1

	Pin No.	B	C	Pins	5 µm tin Sn100	0.15 µm gold
Series 1106 	12	3.3	1.2	32	1106-149-032	1106-121-032
	14	3.7	3.0	32		1106-141-032
	18	3.7	8.1	32		1106-181-032
Series 1107 	14	3.7	3.0	64		1107-141-064 Pins

We deliver the pins in every required number of poles. The insulator can be positioned in every place.

The pin lengths stated in the chart below are stock articles.

We manufacture more pin lengths order related from 60,000 pins.

Single contact pin stock items

A	Tin 5 µm	Gold 0.15 µm	
9.2		x	
10.2			
11.4	x	x	
12.4			
13.5			
15.2			
16.5		x	
17.5			
18.6			

Checklist

Series	<input type="checkbox"/> 1106
Pin length	A1 _____ B + C + 4.7 mm B _____ C _____
Series	<input type="checkbox"/> 1107
Pin length	A1 _____ B + C + 4.7 mm A2 _____ B + C + 9.8 mm B _____ C _____
Surface	<input type="checkbox"/> tin plated <input type="checkbox"/> gold plated 0.15 µm <input type="checkbox"/> gold plated 0.75 µm
Amount of pins	_____
Demand	_____ pieces

11 SMD Pin Connector Pitch 2.54 mm Round contact plug Ø 0.47 mm

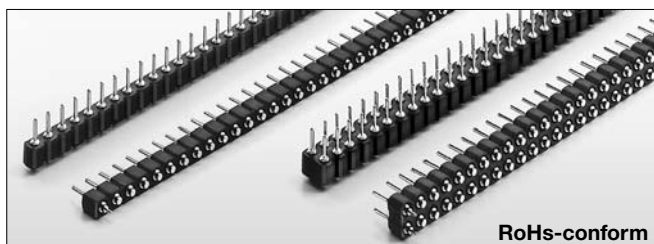

Material typical CuZn alloy
Surface 2-3 µm nickel, 5 µm tin, 0,15 µm gold
Insulator body Thermopl. polyester glass-fibre reinforced, UL 94V0
Operation temper. -55 up to 125 °C
Solder temperature from 235°C acc. IEC 68-2-54 Ta
Solder heat resist. up to 260°C 10 sec. acc. IEC 68-2-20 Tb
Rated voltage 100 V_{RMS} / 150 VDC
Insulation resistance > 10¹⁰ Ω
Air and creepage distance > 1.0 mm
Moisture sensibility level (MSL) J-STD-020C Level 1

	A	Pins	5 µm tin Sn100	0.15 µm gold
Type 1 	81.1	32	1313437	1312476
We deliver the pin connectors in every required number of poles.				
Type 1 	81.1	64	1313232	1312477
We deliver the pin connectors in every required number of poles.				
Type 2 	81.1	32	1313862	1312478
We deliver the pin connectors in every required number of poles.				
Type 2 	40.5 81.1	32 64	1313321 1313864	1313027 1312479
We deliver the pin connectors in every required number of poles.				

12 Pin Connector Pitch 2.54 mm Pin \square 0.635 mm

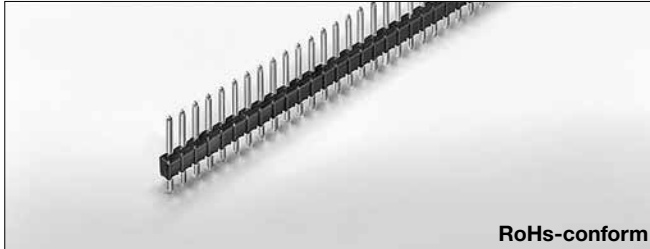

Material typical CuZn alloy
Surface 2-3 μ m nickel, 5 μ m tin, 0,15 μ m gold
Insulator body Thermopl. polyester glass-fibre reinforced, UL 94V0
Operation temper. -55 up to 125 °C
Solder temperature from 235°C acc. IEC 68-2-54 Ta
Solder heat resist. up to 260°C 10 sec. acc. IEC 68-2-20 Tb
Rated voltage 100 V_{RMS} / 150 VDC
Insulation resistance > 10¹⁰ Ω
Air and creepage distance > 1.9 mm
Moisture sensibility level (MSL) J-STD-020C Level 1

Series 1001

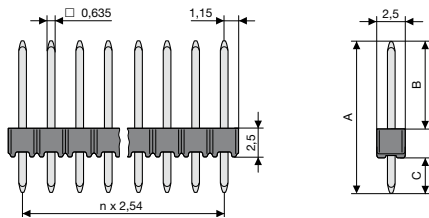

Pin No.	A	B	C	Pins	5 μ m tin Sn100	0.15 μ m gold
11	10.2	5.2	2.5	40	1001-119-040	1001-111-040
12	10.8	5.8	2.5	40	1001-129-040	1001-121-040
13	11.4	6.4	2.5	40	1001-139-040	1001-131-040
14	12.4	7.4	2.5	40	1001-149-040	1001-141-040
15	10.8	5.1	3.2	40	1001-159-040	1001-151-040
16	11.4	5.8	3.1	40	1001-169-040	1001-161-040
17	12.4	6.9	3.0	40	1001-179-040	1001-171-040
18	13.5	8.0	3.0	40	1001-189-040	1001-181-040
38	14.7	9.0	3.2	40	1001-389-040	1001-381-040
19	15.2	9.5	3.2	40	1001-199-040	1001-191-040
39	15.9	10.2	3.2	40	1001-399-040	
20	16.5	10.8	3.2	40	1001-209-040	1001-201-040
21	17.8	12.1	3.2	40	1001-219-040	1001-211-040
22	18.6	12.9	3.2	40	1001-229-040	1001-221-040
40	19.1	13.4	3.2	40	1001-409-040	1001-401-040
41	19.8	14.1	3.2	40	1001-419-040	1001-411-040
23	21.6	15.9	3.2	40	1001-239-040	1001-231-040
24	24.1	18.4	3.2	40	1001-249-040	1001-241-040
25	13.5	5.7	5.3	40	1001-259-040	1001-251-040
26	15.2	5.7	7.0	40	1001-269-040	1001-261-040
27	16.5	5.7	8.3	40	1001-279-040	1001-271-040
28	17.8	5.7	9.6	40	1001-289-040	1001-281-040
29	18.6	5.7	10.4	40	1001-299-040	1001-291-040
30	21.6	5.7	13.4	40	1001-309-040	1001-301-040
31	24.1	5.7	15.9	40	1001-319-040	1001-311-040
32	26.7	5.7	18.5	40	1001-329-040	1001-321-040
33	29.2	5.7	21.0	40	1001-339-040	1001-331-040
34	34.3	5.7	26.0	40	1001-349-040	1001-341-040
42	31.7	5.7	23.5	40	1001-429-040	1001-421-040
43	39.4	5.7	31.2	40	1001-439-040	

We deliver the pins in every required number of poles. The insulator can be positioned in every place.

The pin lengths stated in the chart below are stock articles.

We manufacture more pin lengths order related from 60,000 pins.

Single contact pin stock items

A	Tin	Gold	
	5 μ m	0.15 μ m	0.75 μ m
10.2	x	x	
10.8	x	x	
11.4	x	x	x
12.4	x	x	
13.5	x	x	
14.7	x	x	
15.2	x	x	
15.9	x		
16.5	x	x	
17.8	x	x	
18.6	x	x	
19.1	x	x	
19.8	x	x	
21.6	x	x	
24.1	x	x	
26.7	x	x	
29.2	x	x	
31.7	x	x	
34.3	x	x	
39.4	x		

Checklist

Pin length A _____ B + C + 2.5 mm
 B _____
 C _____

Surface tin plated
 gold plated 0.15 μ m
 gold plated 0.75 μ m

Amount of Pins _____

Demand _____ pieces

13 Pin Connector Pitch 2.54 mm Pin \varnothing 0.635 mm

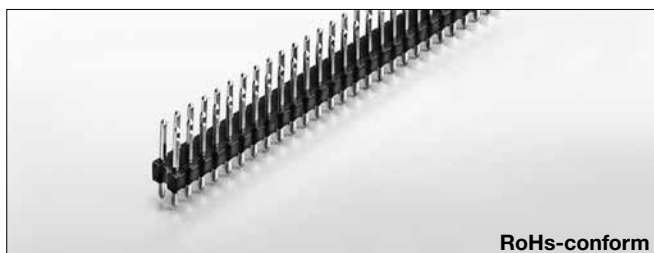

Material typical CuZn alloy
Surface 2-3 μ m nickel, 5 μ m tin, 0,15 μ m gold
Insulator body Thermopl. polyester glass-fibre reinforced, UL 94V0
Operation temper. -55 up to 125 °C
Solder temperature from 235°C acc. IEC 68-2-54 Ta
Solder heat resist. up to 260°C 10 sec. acc. IEC 68-2-20 Tb
Rated voltage 100 V_{RMS} / 150 VDC
Insulation resistance > 10¹⁰ Ω
Air and creepage distance > 1.9 mm
Moisture sensibility level (MSL) J-STD-020C Level 1

Series 1002

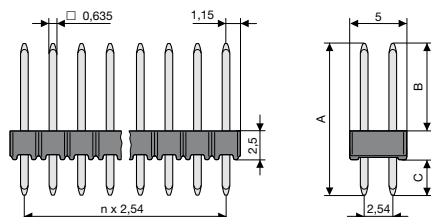

Pin No.	A	B	C	Pins	5 μ m tin Sn100	0.15 μ m gold
11	10.2	5.2	2.5	80	1002-119-080	1002-111-080
12	10.8	5.8	2.5	80	1002-129-080	1002-121-080
13	11.4	6.4	2.5	80	1002-139-080	1002-131-080
14	12.4	7.4	2.5	80	1002-149-080	1002-141-080
15	10.8	5.1	3.2	80	1002-159-080	1002-151-080
16	11.4	5.8	3.1	80	1002-169-080	1002-161-080
17	12.4	6.9	3.0	80	1002-179-080	1002-171-080
18	13.5	8.0	3.0	80	1002-189-080	1002-181-080
38	14.7	9.0	3.2	80	1002-389-080	1002-381-080
19	15.2	9.5	3.2	80	1002-199-080	1002-191-080
39	15.9	10.2	3.2	80	1002-399-080	
20	16.5	10.8	3.2	80	1002-209-080	1002-201-080
21	17.8	12.1	3.2	80	1002-219-080	1002-211-080
22	18.6	12.9	3.2	80	1002-229-080	1002-221-080
40	19.1	13.4	3.2	80	1002-409-080	1002-401-080
41	19.8	14.1	3.2	80	1002-419-080	1002-411-080
23	21.6	15.9	3.2	80	1002-239-080	1002-231-080
24	24.1	18.4	3.2	80	1002-249-080	1002-241-080
25	13.5	5.7	5.3	80	1002-259-080	1002-251-080
26	15.2	5.7	7.0	80	1002-269-080	1002-261-080
27	16.5	5.7	8.3	80	1002-279-080	1002-271-080
28	17.8	5.7	9.6	80	1002-289-080	1002-281-080
29	18.6	5.7	10.4	80	1002-299-080	1002-291-080
30	21.6	5.7	13.4	80	1002-309-080	1002-301-080
31	24.1	5.7	15.9	80	1002-319-080	1002-311-080
32	26.7	5.7	18.5	80	1002-329-080	1002-321-080
33	29.2	5.7	21.0	80	1002-339-080	1002-331-080
34	34.3	5.7	26.0	80	1002-349-080	1002-341-080
42	31.7	5.7	23.5	80	1002-429-080	1002-421-080
43	39.4	5.7	31.2	80	1002-439-080	

We deliver the pins in every required number of poles. The insulator can be positioned in every place.

The pin lengths stated in the chart below are stock articles.

We manufacture more pin lengths order related from 60,000 pins.

Single contact pin stock items

A	Tin 5 μ m	Gold	
		0.15 μ m	0.75 μ m
10.2	x	x	
10.8	x	x	
11.4	x	x	x
12.4	x	x	
13.5	x	x	
14.7	x	x	
15.2	x	x	
15.9	x		
16.5	x	x	
17.8	x	x	
18.6	x	x	
19.1	x	x	
19.8	x	x	
21.6	x	x	
24.1	x	x	
26.7	x	x	
29.2	x	x	
31.7	x	x	
34.3	x	x	
39.4	x		

Checklist

Pin length A _____ B + C + 2.5 mm
 B _____
 C _____

Surface tin plated
 gold plated 0.15 μ m
 gold plated 0.75 μ m

Amount of pins _____

Demand _____ pieces

14 Pin Connector Pitch 2.54 mm Pin \varnothing 0.635 mm

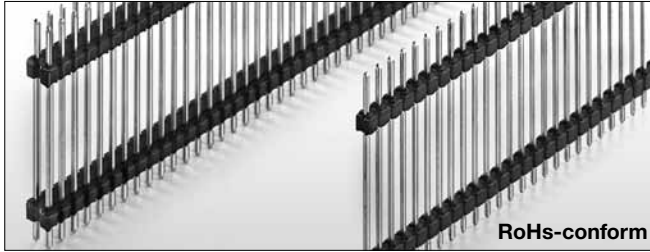

Material typical CuZn alloy
Surface 2-3 μ m nickel, 5 μ m tin, 0,15 μ m gold
Insulator body Thermopl. polyester glass-fibre reinforced, UL 94V0
Operation temper. -55 up to 125 °C
Solder temperature from 235°C acc. IEC 68-2-54 Ta
Solder heat resist. up to 260°C 10 sec. acc. IEC 68-2-20 Tb
Rated voltage 100 V_{RMS} / 150 VDC
Insulation resistance > 10¹⁰ Ω
Air and creepage distance > 1.9 mm
Moisture sensibility level (MSL) J-STD-020C Level 1

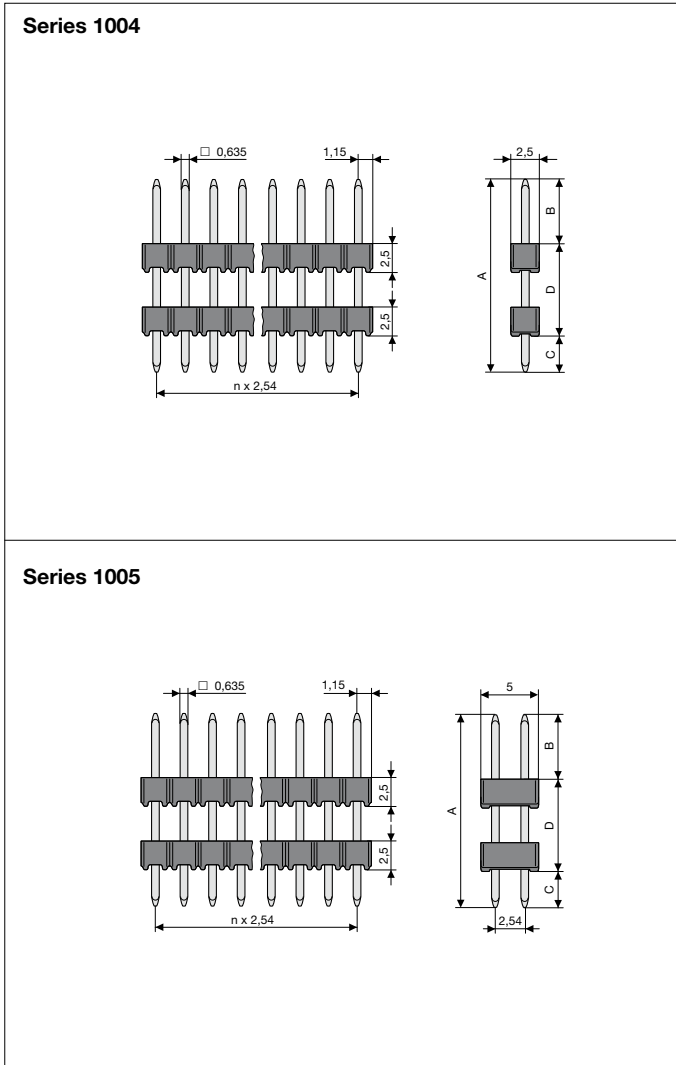

Pin No.	A	B	C	D	Pins	5 μ m tin Sn100	0.15 μ m gold
13	17.8	5.7	3.2	8.9	40	1004-139-040	1004-131-040
14	18.6	5.7	3.2	9.7	40	1004-149-040	1004-141-040
15	21.6	5.7	3.2	12.7	40	1004-159-040	1004-151-040
16	24.1	5.7	3.2	15.2	40	1004-169-040	1004-161-040
17	26.7	5.7	3.2	17.8	40	1004-179-040	1004-171-040
18	29.2	5.7	3.2	20.3	40	1004-189-040	1004-181-040
36	31.7	5.7	3.2	22.8	40	1004-369-040	1004-361-040
19	34.3	5.7	3.2	25.4	40	1004-199-040	1004-191-040
20	39.4	5.7	3.2	30.5	40	1004-209-040	
22	16.5	3.2	3.2	10.1	40	1004-229-040	1004-221-040
23	17.8	3.2	3.2	11.4	40	1004-239-040	1004-231-040
24	18.6	3.2	3.2	12.1	40	1004-249-040	1004-241-040
25	21.6	3.2	3.2	15.2	40	1004-259-040	1004-251-040
26	24.1	3.2	3.2	17.7	40	1004-269-040	1004-261-040
27	26.7	3.2	3.2	20.3	40	1004-279-040	1004-271-040
28	29.2	3.2	3.2	22.8	40	1004-289-040	1004-281-040
37	31.7	3.2	3.2	25.3	40	1004-379-040	1004-371-040
29	34.3	3.2	3.2	27.9	40	1004-299-040	1004-291-040
30	39.4	3.2	3.2	33.0	40	1004-309-040	
							Pins
13	17.8	5.7	3.2	8.9	80	1005-139-080	1005-131-080
14	18.6	5.7	3.2	9.7	80	1005-149-080	1005-141-080
15	21.6	5.7	3.2	12.7	80	1005-159-080	1005-151-080
16	24.1	5.7	3.2	15.2	80	1005-169-080	1005-161-080
17	26.7	5.7	3.2	17.8	80	1005-179-080	1005-171-080
18	29.2	5.7	3.2	20.3	80	1005-189-080	1005-181-080
36	31.7	5.7	3.2	22.8	80	1005-369-080	1005-361-080
19	34.3	5.7	3.2	25.4	80	1005-199-080	1005-191-080
20	39.4	5.7	3.2	30.5	80	1005-209-080	
22	16.5	3.2	3.2	10.1	80	1005-229-080	1005-221-080
23	17.8	3.2	3.2	11.4	80	1005-239-080	1005-231-080
24	18.6	3.2	3.2	12.1	80	1005-249-080	1005-241-080
25	21.6	3.2	3.2	15.2	80	1005-259-080	1005-251-080
26	24.1	3.2	3.2	17.7	80	1005-269-080	1005-261-080
27	26.7	3.2	3.2	20.3	80	1005-279-080	1005-271-080
28	29.2	3.2	3.2	22.8	80	1005-289-080	1005-281-080
37	31.7	3.2	3.2	25.3	80	1005-379-080	1005-371-080
29	34.3	3.2	3.2	27.9	80	1005-299-080	1005-291-080
30	39.4	3.2	3.2	33.0	80	1005-309-080	
							Pins

We deliver the pins in every required number of poles. The insulator can be positioned in every place.

The pin lengths stated in the chart below are stock articles.

We manufacture more pin lengths order related from 60,000 pins.

Single contact pin stock items

A	Sn/ μ m		Au/ μ m	
	5	0.15	0.75	
10.2	x	x		
10.8	x	x		
11.4	x	x	x	
12.4	x	x		
13.5	x	x		
14.7	x	x		
15.2	x	x		
15.9	x			
16.5	x	x		
17.8	x	x		
18.6	x	x		
19.1	x	x		

A	Sn/ μ m		Au/ μ m	
	5	0.15	0.75	
19.8	x	x		
21.6	x	x		
24.1	x	x		
26.7	x	x		
29.2	x	x		
31.7	x	x		
34.3	x	x		
39.4	x			

Checklist

Series 1004 1005

Pin length A _____ B + C + D mm
 B _____
 C _____

Surface tin plated
 gold plated 0.15 μ m
 gold plated 0.75 μ m

Amount of pins _____

Demand _____ pieces

15 Pin Connector Pitch 2.54 mm Pin \varnothing 0.635 mm



Material typical CuZn alloy
Surface 2-3 μ m nickel, 5 μ m tin, 0,15 μ m gold
Insulator body Thermopl. polyester glass-fibre reinforced, UL 94V0
Operation temper. -55 up to 125 °C
Solder temperature from 235°C acc. IEC 68-2-54 Ta
Solder heat resist. up to 260°C 10 sec. acc. IEC 68-2-20 Tb
Rated voltage 100 V_{RMS} / 150 VDC
Insulation resistance > 10¹⁰ Ω
Air and creepage distance > 1.9 mm
Moisture sensibility level (MSL) J-STD-020C Level 1

Series 1006

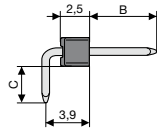
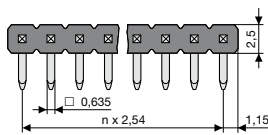

Pin No.	B	C	Pins	5 μ m tin Sn100	0.15 μ m gold
21	3.1	3.1	40	1006-219-040	1006-211-040
12	6.4	2.5	40	1006-129-040	1006-121-040
14	5.8	3.1	40	1006-149-040	1006-141-040
15	6.9	3.2	40	1006-159-040	1006-151-040
16	5.7	6.2	40	1006-169-040	1006-161-040
17	5.7	8.8	40	1006-179-040	1006-171-040
18	5.7	11.3	40	1006-189-040	1006-181-040
19	5.7	13.8	40	1006-199-040	1006-191-040
					Pins

21	3.1	3.1	80	1007-219-080	
12	6.4	2.5	80	1007-129-080	1007-121-080
14	5.8	3.1	80	1007-149-080	1007-141-080
15	6.9	3.2	80	1007-159-080	1007-151-080
16	5.7	6.2	80	1007-169-080	1007-161-080
17	5.7	8.8	80	1007-179-080	1007-171-080
18	5.7	11.3	80	1007-189-080	1007-181-080
19	5.7	13.8	80	1007-199-080	1007-191-080
					Pins

Series 1007

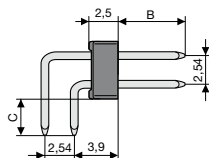
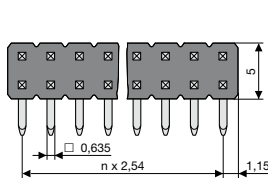

We deliver the pins in every required number of poles. The insulator can be positioned in every place.

The pin lengths stated in the chart below are stock articles.

We manufacture more pin lengths order related from 60,000 pins.

Single contact pin stock items

A	Tin	Gold	
	5 μ m	0.15 μ m	0.75 μ m
10.2	x	x	
10.8	x	x	
11.4	x	x	x
12.4	x	x	
13.5	x	x	
14.7	x	x	
15.2	x	x	
15.9	x		
16.5	x	x	
17.8	x	x	
18.6	x	x	
19.1	x	x	
19.8	x	x	
21.6	x	x	
24.1	x	x	

Checklist

Series 1006

Pin length A1 _____ B + C + 4.6 mm
 B _____
 C _____

Series 1007

Pin length A1 _____ B + C + 4.6 mm
 A2 _____ B + C + 9.7 mm
 B _____
 C _____

Surface tin plated
 gold plated 0.15 μ m
 gold plated 0.75 μ m

Amount of pins _____

Demand _____ pieces

16 Pin Connector Pitch 2.54 mm Pin \varnothing 0.635 mm



Material typical CuZn alloy
Surface 2-3 μ m nickel, 0,15 μ m gold
Insulator body Thermopl. polyester glass-fibre reinforced, UL 94V0
Operation temper. -55 up to 125 °C
Solder temperature from 235°C acc. IEC 68-2-54 Ta
Solder heat resist. up to 260°C 10 sec. acc. IEC 68-2-20 Tb
Rated voltage 100 V_{RMS} / 150 VDC
Insulation resistance > 10¹⁰ Ω
Air and creepage distance > 1.9 mm
Moisture sensibility level (MSL) J-STD-020C Level 1

Pin No.	A	B	C	Pins	0.15 μ m gold		
Series 1003 	16 17	11.4 12.4	5.8 6.9	3.1 3.0	150 150	1003-161-150 1003-171-150 Pins	
Series 1008 	15	–	6.9	3.3	150	1008-151-150 Pins	

17 Pin Connector Pitch 2.54 mm Pin \varnothing 0.635 mm

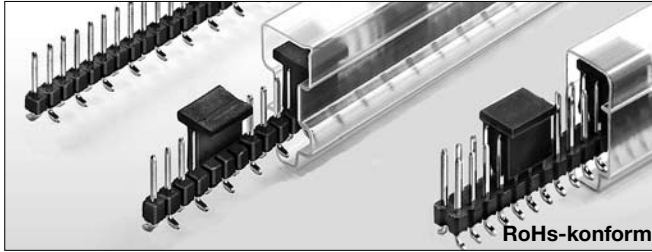

Material typical CuZn alloy
Surface 2-3 μ m nickel, 5 μ m tin, 0,15 μ m gold
Insulator body Thermopl. polyester glass-fibre reinforced, UL 94V0
Operation temper. -55 up to 125 °C
Solder temperature from 235°C acc. IEC 68-2-54 Ta
Solder heat resist. up to 260°C 10 sec. acc. IEC 68-2-20 Tb
Rated voltage 100 V_{RMS} / 150 VDC
Insulation resistance > 10¹⁰ Ω
Air and creepage distance > 1.9 mm
Moisture sensibility level (MSL) J-STD-020C Level 1

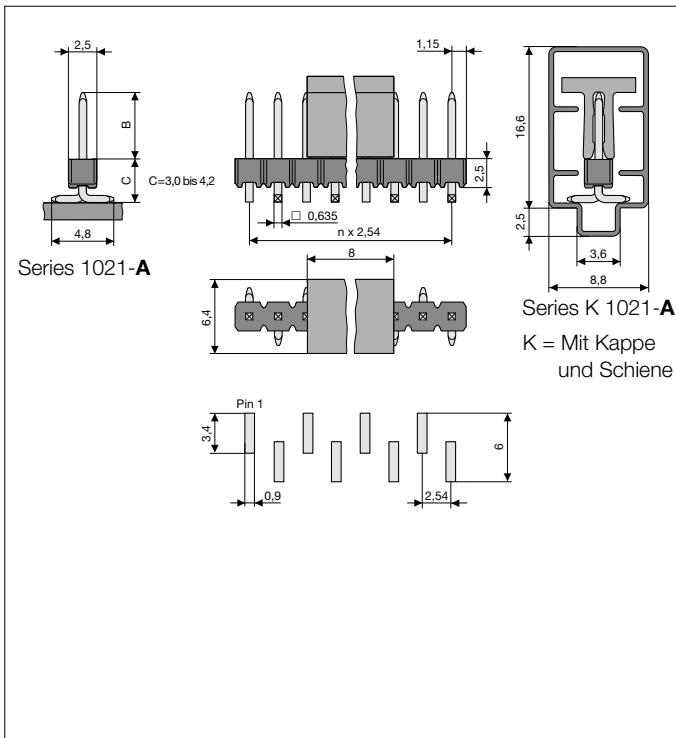

A	B	C	Pins	5 μ m tin Sn100	0.15 μ m gold
11.4	5.8	3.8	40	1021-A-169-040	1021-A-161-040
12.4	6.9	3.7	40	1021-A-179-040	1021-A-171-040
					Pins
11.4	5.8	3.8	40	K 1021-A-169-040	K 1021-A-161-040
12.4	6.9	3.7	40	K 1021-A-179-040	K 1021-A-171-040

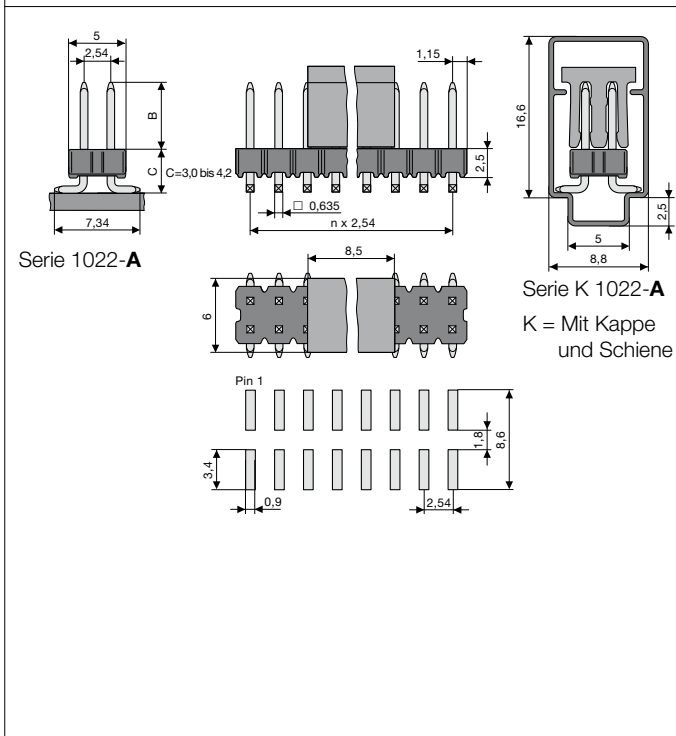

11.4	5.8	3.8	80	1022-A-169-080	1022-A-161-080
12.4	6.9	3.7	80	1022-A-179-080	1022-A-171-080
					Pins
11.4	5.8	3.8	80	K 1022-A-169-080	K 1022-A-161-080
12.4	6.9	3.7	80	K 1022-A-179-080	K 1022-A-171-080

More pin lengths on request

18 Female Jumpers Pitch 2.54 mm for square Pins \square 0.635 mm



Insulated female jumpers for square pins, connectable in series.

Material Phosphor bronze
Operation temperature -40 up to 105°C
Rated voltage 250V AC, DC
Contact resistance < 20 mΩ
Insulation resistance >1000 MΩ

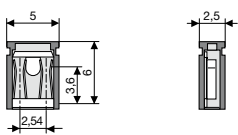
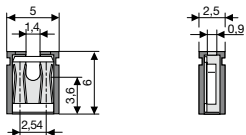
	Colour plastic	Pins	Gold flash	
			Packaging unit 2000	Packaging unit 100
Closed design 	black	1	3300101	3300113
	red	1	3300092	3300114
Open design 	black	1	3300096	3300111
	red	1	3300097	3300559

19 Male Jumpers for IC Sockets and Socket Connectors

Male jumpers with pitch 2.54/5.08/7.62 mm, optional with or without insulator body.

With the sidewise displaced nipple the jumper can be easily plugged in and drawn off.

For measures in plugged-in position a drill-hole is positioned in the middle of the insulator body.

Material typical CuZn alloy

Surface nickel 2 - 3 µm, gold 0.15 µm or tin 5 µm (Sn100)

Insulator body Thermoplastic Polyester self-extinguishing rated UL94V0

Operation temperature -55 up to +125°C.

Rated voltage 100 V_{RMS}/150 VDC

Breakdown voltage 1000 V_{RMS}

Insulation resistance >10¹⁰ Ω

Contact resistance ≤ 10 mΩ

Air and creepage distance > 0,7 mm

Current carrying capacity 3 A

Moisture sensibility level (MSL)

J-STD-020C Level 1

RoHS-conform

The technical data refer to IC Sockets and Socket Connectors with pitch 2.54 mm.

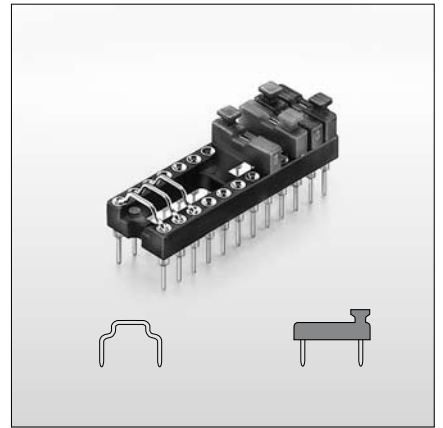
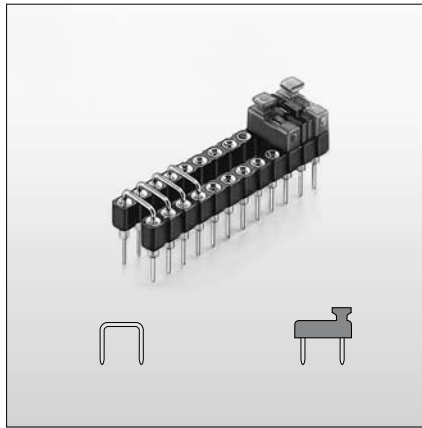
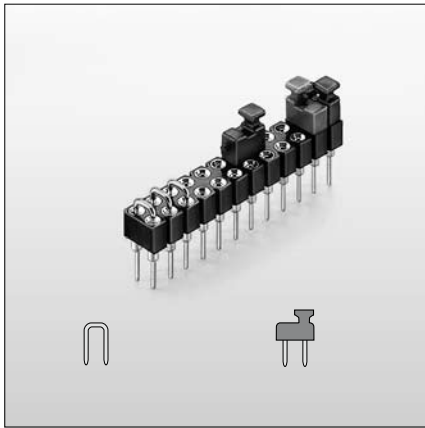

	Surface				0.15 µm Gold	5 µm Tin
	A	B	Plastic colour	PU	Bestell-Nr.	
	0.56	2.54		1000	11.1110	11.1190
	0.56	5.08		1000	11.1210	11.1290
	0.56	7.62		1000	11.1310	11.1390
	0.5	2.54		1000	41.1110	41.1190
	0.5	5.08		1000	41.1210	41.1290
	0.5	7.62		1000	41.1310	41.1390
	0.56	2.54	black	100	11.2110	11.2190
	0.56	2.54	red	100	11.2111	11.2191
	0.56	5.08	black	100	11.2210	11.2290
	0.56	5.08	red	100	11.2211	11.2291
	0.56	7.62	black	100	11.2310	11.2390
	0.56	7.62	red	100	11.2311	11.2391

PU = Packaging Unit

20 DIL-Capacitor Sockets Series K1-110

The capacitor socket is used in bus drivers or storages to avoid voltage dips during switching.

The connecting cable of the capacitor is injected with the socket contact.

Highest contact safety due to 4 multi-disc contact spring made of Beryllium copper with homogeneous gilding.

8- to 40-pin, all side arrangable. For PCB's up to 2.0 mm thickness.

No capillary action during soldering due to screened inner contact (no fluxing medium or tin in the contact area).

Contact clip Beryllium copper
Surface nickel 2 - 3 μm , gold flash

Sleeve typical CuZn alloy turned
Surface tin (Sn100)

Insulator body Thermoplastic polyester
glass-fibre reinforced, self-extinguishing rated UL94V0.

Operation temperature -55 up to +125°C

Solder temperature
from 235°C acc. IEC 68-2-54 Ta

Solder head resistance
up to 260°C 10 sec. acc. IEC 68-2-20 Tb

Contact depth 2.4 mm by safe contact making

Accepted diameter 0.4 - 0,56 mm

Rated voltage max. 50 VDC

Insulation resistance $>10^{10} \Omega$

Contact resistance $\leq 10 \text{ m}\Omega$

Air and creepage distance $> 0.7 \text{ mm}$

Current carrying capacity per contact 1 A

Moisture sensibility level (MSL)
J-STD-020C Level 1

RoHS-conform



Ceramic multi level capacitor Z5U

Capacity 0,1 $\mu\text{F} \pm 20\%$

Rated voltage max. 50 VDC

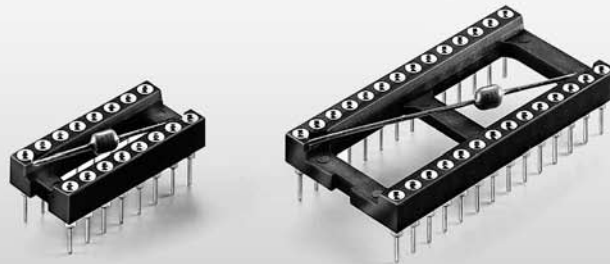
Operating temperature -25 up to +125°C

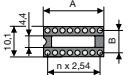
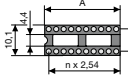
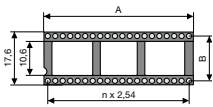
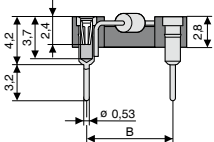

	Sleeve 		Clip 		5 μm tin		
	A	B	Pins	PU	Gold flash	Order No.	Min. order amount
	10.1	7.62	8	52		K1 110-87-308	11,370
	17.7	7.62	14	29		K1 110-87-314	
	20.3	7.62	16	25		K1 110-87-316	
	22.8	7.62	18	22		K1 110-87-318	5,060
	25.3	7.62	20	20		K1 110-87-320	
	30.4	7.62	24	17		K1 110-87-324	
	30.4	15.24	24	17		K1 110-87-624	2,550
	35.4	15.24	28	14		K1 110-87-628	
	40.6	15.24	32	12		K1 110-87-632	
	50.6	15.24	40	10		K1 110-87-640	
<p>For pins \varnothing 0,4 up to 0,56 mm \square 0,25 x 0,45 mm</p> 	More sizes on request						

PU = Packaging Unit

21 DIL-Sockets with pin contacts SMD

The SMD Sockets are delivered in three versions:

- Type 1 All pins with SMD connection
- Type 2 The connection on the four corners have additional fixing knobs. The print of the soldering paste can be carried out like type 1.
- Type 3 All pins are fitted with additional fixing knobs (on request).

Material typical CuZn alloy turned
Surface nickel 2 - 3 μm ,
 tin 5 μm (Sn100) or
 gold 0.15 μm

Insulator body Thermoplastic polyester
 glass-fibre reinforced, self-
 extinguishing rated UL94V0.

Operation temperature -55 up to +125°C

Solder temperature
 from 235°C acc. IEC 68-2-54 Ta

Solder head resistance
 up to 260°C 10 sec. acc. IEC 68-2-20 Tb

Rated voltage 100 V_{RMS}/150 VDC
Insulation resistance > 10¹⁰ Ω
Air and creepage distance > 1,0 mm
Current carrying capacity per contact 1 A
Moisture sensibility level (MSL)
 J-STD-020C Level 1

RoHS-conform

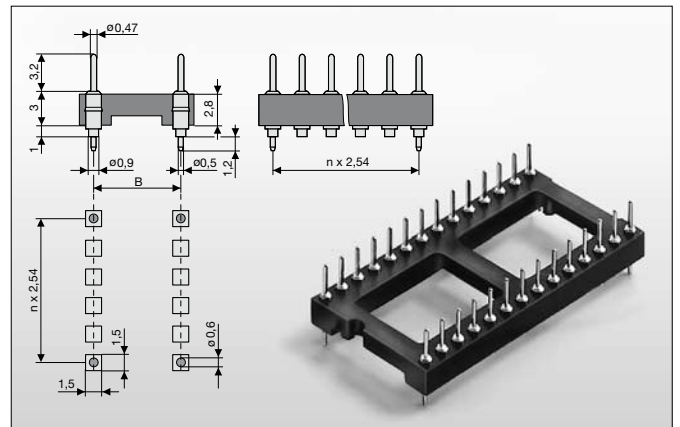
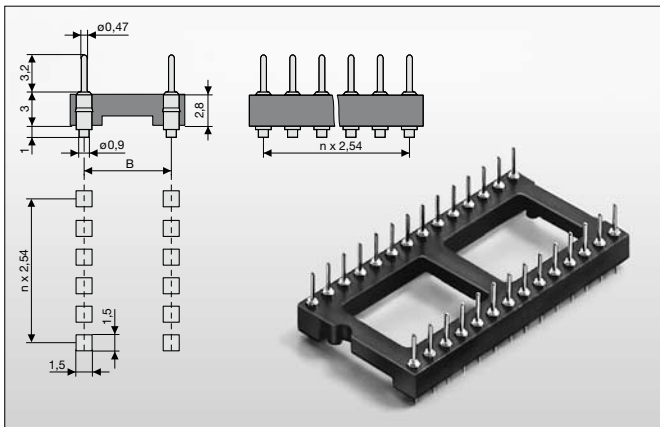

	Surface				0.15 μm gold		5 μm tin	
	A	B	Pins	PU	Part No.			
					Type 1	Type 2	Type 1	Type 2
	7.6	7.62	6	69				
	10.1	7.62	8	52			1008130	1008131
	17.7	7.62	14	29	1008465		1009121	1008280
	20.3	7.62	16	25	1008297	1009469	1009037	1008281
	22.8	7.62	18	22	1008403		1008505	1008282
	25.3	7.62	20	20	1008298	1008296		1008283
	30.4	7.62	24	17		1008708		1008284
	35.5	7.62	28	14				1008265
	30.4	10.16	24	17				1008285
	35.5	10.16	28	14				1008286
	40.6	10.16	32	12				1008287
	30.4	15.24	24	17			1009282	1008288
	35.5	15.24	28	14				1008289
	40.6	15.24	32	12	1008670	1008669		1008290
	50.6	15.24	40	10	1009153		1009328	1008291
	60.9	15.24	48	8				1008168
65.9	15.24	52	7				1008294	
More sizes on request								

PU = Packaging Unit

22 Converter Sockets DIL → SOP Reduction Sockets DIL → DIL Series 599

- ① Converter socket DIL → SOP solder on the PCB.
- ② Converter socket Skinny DIL → DIL
No capillary action during soldering due to screened inner contact. No fluxing medium or tin in the contact area.

Contact clip Surface Beryllium copper
Nickel 2 - 3 µm, gold flash

Contact pin Surface typical CuZn alloy turned
nickel 2 - 3 µm,
tin 5 µm (Sn100)

Insulator body Thermoplastic polyester
glass-fibre reinforced, self-extinguishing rated UL94V0.

PCB Glas-fibre Epoxyd EP-GC 02,
self-extinguishing rated UL94V0,
(35 µm copper tin-plated Sn100
or chemical Ni/Au)

Operation temperature -55 up to +125 °C

Solder temperature
from 235°C acc. IEC 68-2-54 Ta

Solder head resistance
up to 260°C 10 sec. acc. IEC 68-2-20 Tb

Contact depth 2.4 mm by safe contact making

Accepted diameter 0.4 - 0.56 mm

Mechanical life > 50

Rated voltage 100 V_{RMS}/150 VDC

Contact resistance < 30 mΩ

Insulation resistance > 5 × 10⁹ Ω

Air and creepage distance PCB > 0.3 mm
Insulator body > 0.7 mm

Current carrying capacity per contact 1 A

Moisture sensibility level (MSL)

J-STD-020C Level 1

RoHS-conform

- ① The DIL → SOP Converter socket can be inserted or soldered as required.

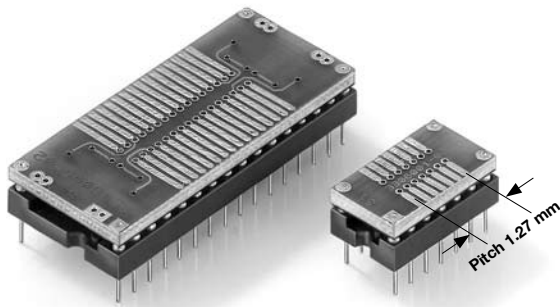

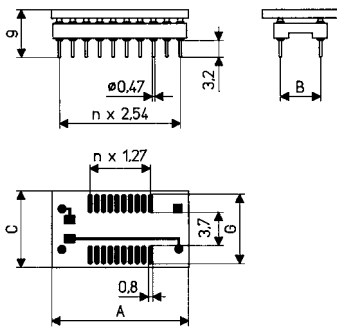
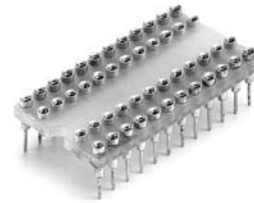

- ② Skinny DIL → DIL Converter sockets for electrically similar components with different widths and pitches.

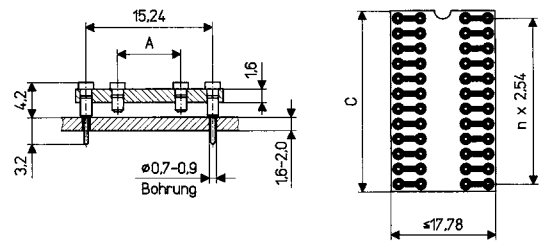

Series 599



A	B	C	G	Pins	PU	Converter Socket	Part No.
10.2	7.62	10.2	9.8	8	52	SOP8-DIP308	3305702
17.8	7.62	10.2	9.8	14	29	SOP14-DIP314	3305704
20.4	7.62	10.2	9.8	16	25	SOP16-DIP316	3305706
20.4	7.62	14.0	13.2	16	25	SOP16W-DIP316	3305708
22.9	7.62	14.0	13.2	18	22	SOP18-DIP318	3305749
25.5	7.62	10.2	9.8	20	20	SOP20-DIP320	3305710
25.5	7.62	14.7	13.9	20	20	SOP20W-DIP320	3305712
30.5	7.62	17.8	16.8	24	17	SOP24-DIP324	3305750
30.5	15.24	17.8	16.8	24	17	SOP24-DIP624	3305714
35.6	7.62	17.8	16.8	28	14	SOP28-DIP328	3305752
35.6	15.24	17.8	16.8	28	14	SOP28-DIP628	3305716
40.7	15.24	17.8	16.8	32	12	SOP32-DIP632	3305718

Surface		Sleeve → 		5 µm tin	
		Clip → 		Gold flash	
A	C	Pins	PU	Part No. New	Part No. Old
7.62	31.0	24	17	1005221	599-87-048-1501
7.62	36.2	28	14	1005860	599-87-056-1503
7.62	41.2	32	12	1004108	599-87-064-1505

W = Design „Wide“

PU = Packaging Unit

23 LED-Sockets

The constructional depth of the LED-displays have to be aligned precisely to the mechanical conditions.

If there are several displays mounted side by side, a joint insulator is appropriate. Due to the insulator all displays are mounted on the same height. The socket connectors given below can be mounted. More construction depths on request.

The LED-Sockets are manufactured on customer order. Please use the design specification given below for your request.

- Contact clip Surface** Beryllium copper nickel 2 - 3 μm , gold 0.75 μm (-83-) or gold flash (-87-)
- Sleeve Surface** typical CuZn alloy turned Nickel 2 - 3 μm , tin 5 μm (Sn100)
- Insulator body** Thermoplastic polyester glass-fibre reinforced, self-extinguishing rated UL94V0.
- Operation temperature** -55 up to +125 °C

- Solder temperature** from 235°C acc. IEC 68-2-54 Ta
- Solder head resistance** up to 260°C 10 sec. acc. IEC 68-2-20 Tb
- Contact depth** 2.4 mm by safe contact making
- Accepted diameter** 0.4 mm - 0.56 mm
- Rated voltage** 100 V_{RMS}/150 VDC
- Insulation resistance** >10¹⁰ Ω
- Contact resistance** \leq 10 m Ω
- Air and creepage distance** > 0.7 mm
- Current carrying capacity** per contact 1 A
- Moisture sensibility level (MSL)** J-STD-020C Level 1

RoHS-conform

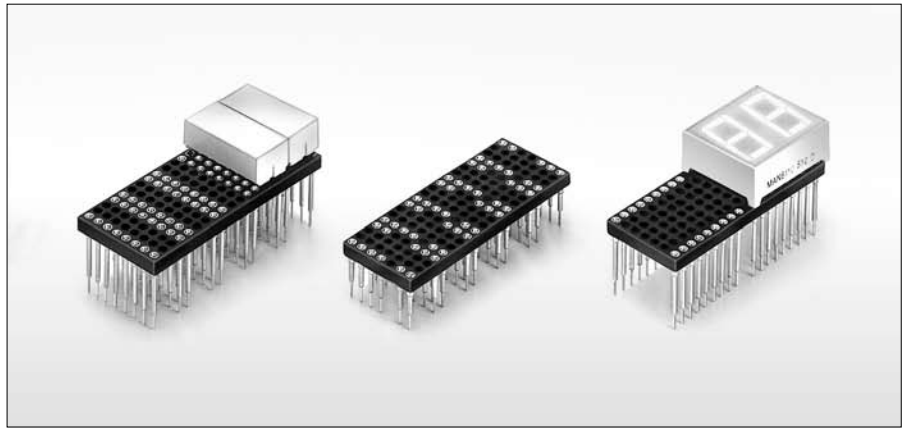
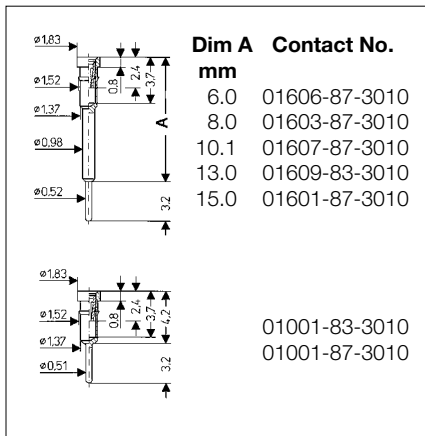

1. Footprints

Distance of drillings 2.54 mm

Example

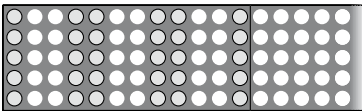

2. Order No. single contacts

3. Amount of single contacts

_____ pieces

4. Demand

_____ pieces sample

_____ pieces mass produce

5. Address

The LED-socket can be manufactured with different socket connectors. Due to your footprint and the definition of the single contact the LED-socket will be produced.

Insulator body 1100368



Thickness of insulator body 2.8 mm

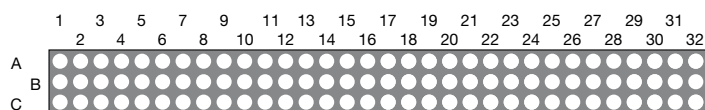
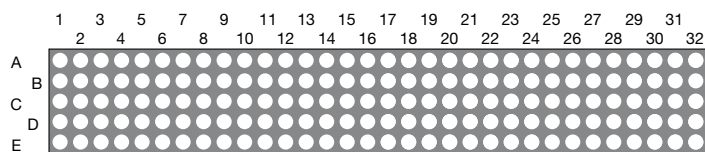
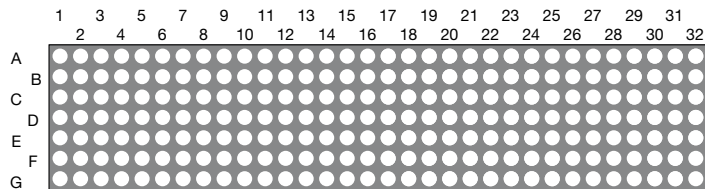

Bauteilseite

25 PLCC-Adapter Series 531

The angled SMD connections with a large soldering area ensure a high draw-off strength.

Suitable for all PLCC sockets in JEDEC Type A design.

The massive square pins guarantee a safe connection. The pin length of 5.5 mm in the insertion area ensure a safe contact. For particularly low component height, the insertion depth can be reduced to 4.6 mm.

The drill-holes in the insulated body enable the socket to be fixed onto the PCB.

Contact pin Surface typically CuZn alloy
2-3 µm nickel,
0.15 µm gold

Insulator body Thermoplastic polyester
glass-fibre reinforced, self-extinguishing rated UL94V0.

Operation temperature -55 up to +125 °C

Solder temperature from 235°C acc. IEC 68-2-54 Ta

Solder head resistance up to 260°C 10 sec. acc. IEC 68-2-20 Tb

Mechanical life > 500 cycles
Rated voltage 100 V_{RMS}/150 VDC
Insulation resistance > 10¹⁰ Ω
Air and creepage distance >0.6 mm
Current carrying capacity per contact 1 A
Moisture sensibility level (MSL) J-STD-020C Level 1

RoHS-conform

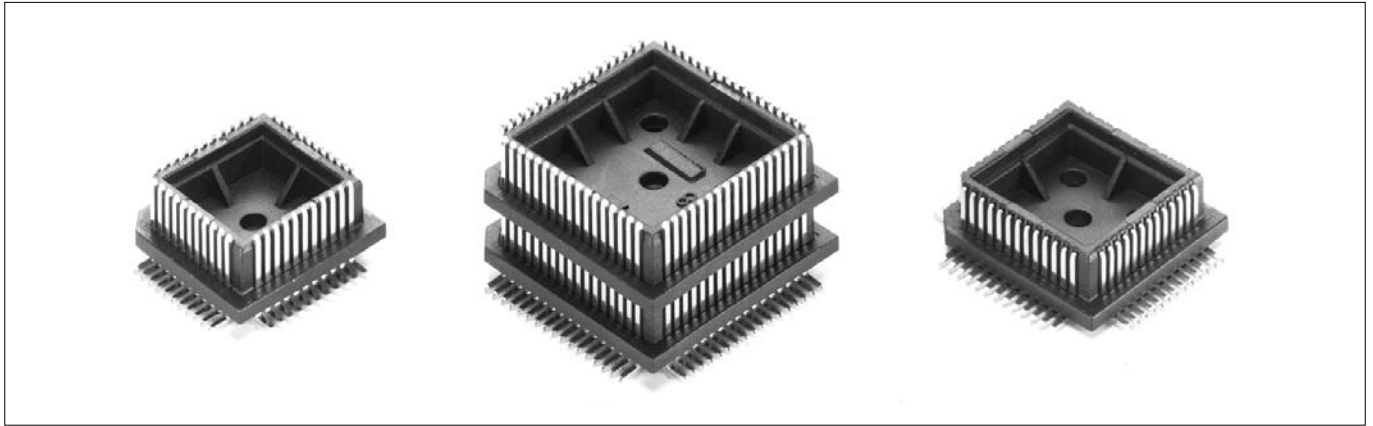

Customer Specific Design

Type: 1 2 3
Length: A = _____ A = _____
M = A - 2.1 mm M = A - 3.1 mm
K = 5.5 mm K = 4.6 mm

Surface: tinned
 gold plated 0.15 µm
 gold plated 0.75 µm

Pin count: _____

Single contact pin stock items

A	Gold 0.15 µm	
10.2	x	
10.8	x	
11.4	x	
12.4	x	
13.5	x	
14.7	x	
15.2	x	
16.5	x	
17.8	x	
19.1	x	
19.8	x	
21.6	x	
24.1	x	
26.7	x	
29.2	x	

Custom lengths and surface finishes for 60,000 pins or more

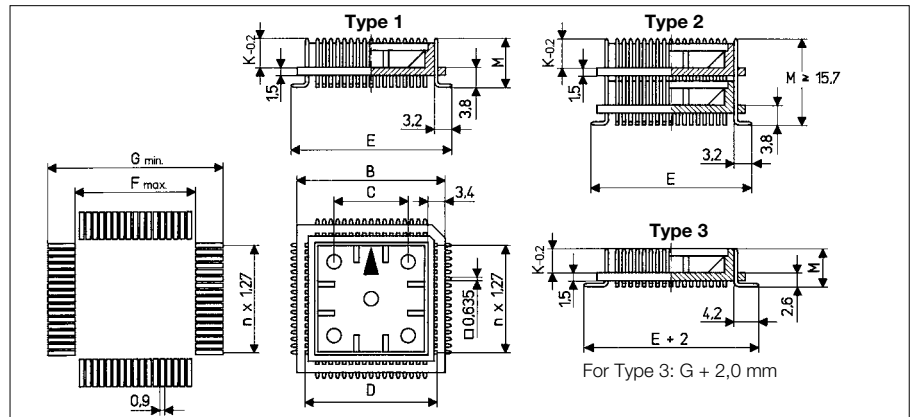

							Type	1	2	3			
							M	9.3	15.7	7.1			
							K	5.5	5.5	4.6			
B	C	D	E	F	G	Pins	Part No.						
							Pin contact 0.15 µm gold plated						
12.8		9.8	15.0	6.7	15.9	20							
15.3		12.3	17.4	9.2	18.4	28	3306811	3306911	3307311				
15.3		12.3	17.4	9.2	19.4	32	3306821	3306921	3307321				
18.0		14.9	20.0	11.8	22.0	32							
20.3		17.4	22.5	14.3	24.5	44	3306831	3306931	3307331				
23.0	9.5	19.9	25.1	16.8	27.1	52	3306841	3306941	3307341				
28.0	14.0	25.0	30.1	21.9	32.1	68	3306851	3306951	3307351				
33.0	17.8	30.1	35.2	26.8	37.2	84	3306861	3306961	3307062				

26 PLCC-Adapter Series 532

For insertion into PCB's or to be soldered in SMD.

Suitable for all PLCC sockets in JEDEC Type A design.

The massive square pins guarantee a safe connection. The pin length of 5.5 mm in the insertion area ensure a safe contact. For particularly low component height, the insertion depth can be reduced to 4.6 mm.

The drill-holes in the insulated body enable the socket to be fixed onto the PCB.

Contact pin Surface typically CuZn alloy
2-3 µm nickel,
0.15 µm gold

Insulator body Thermoplastic polyester
glass-fibre reinforced, self-extinguishing rated UL94V0.

Operation temperature -55 up to +125 °C

Solder temperature from 235°C acc. IEC 68-2-54 Ta

Solder head resistance up to 260°C 10 sec. acc. IEC 68-2-20 Tb

Mechanical life > 500 cycles
Rated voltage 100 V_{RMS}/150 VDC
Insulation resistance > 10¹⁰ Ω
Air and creepage distance >0.6 mm
Current carrying capacity per contact 1 A
Moisture sensibility level (MSL) J-STD-020C Level 1

RoHS-conform

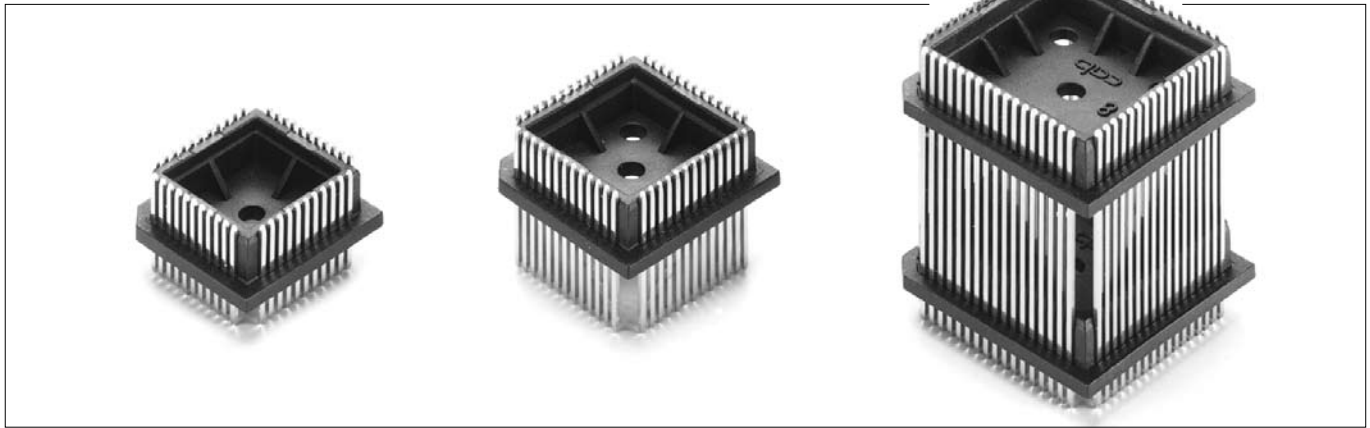

Customer specific design

Type: 1 2

Length: A = _____

L = _____

K = 4,6 mm 5,5 mm

Surface: tinned

gold plated 0.15 µm

gold plated 0.75 µm

Pin count: _____

Single contact pin stock items

A	Gold 0.15 µm	
10.2	x	
10.8	x	
11.4	x	
12.4	x	
13.5	x	
14.7	x	
15.2	x	
16.5	x	
17.8	x	
19.1	x	
19.8	x	
21.6	x	
24.1	x	
26.7	x	
29.2	x	

Custom lengths and surface finishes for 60,000 pins or more

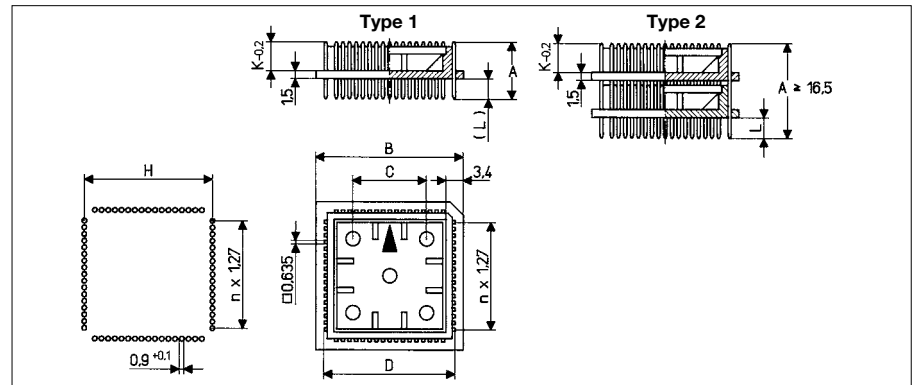

				Type	1	1	2	2	
				A	10.8	15.2	16.5	29.2	
				K	5.5	5.5	5.5	5.5	
				L	3.8	8.2	3.5	3.5	
B	C	D	H	Pins	Part No.				
					Contact pin 0.15 µm gold plated				
12.8		9.8	9.2	20					
15.3		12.3	11.7	28	3306812	3306912	3307812	3307512	
15.3		12.3	11.7	32	3306822	3306922	3307822	3307522	
18.0		14.9	14.2	44	3306832	3306932	3307832	3307532	
20.3		17.4	16.8	52	3306842	3306942	3307842	3307542	
23.0	9.5	19.9	19.3	68	3306852	3306952	3307852	3307552	
28.0	14.0	25.0	24.4	84	3306862	3306962	3307862	3307562	

27 PLCC-Adapter Series 533

Suitable for all PLCC sockets in JEDEC Type A design.

The massive square pins guarantee a safe connection. The pin length of 5.5 mm in the insertion area ensures a safe contact. For particularly low component height, the insertion depth can be reduced to 4.6 mm.

The drill-holes in the insulated body enable the socket to be fixed onto the PCB.

Contact pin Surface typically CuZn alloy
2-3 µm nickel,
0.15 µm gold

Insulator body Thermoplastic polyester
glass-fibre reinforced, self-extinguishing rated UL94V0.

Operation temperature -55 up to +125 °C

Solder temperature
from 235°C acc. IEC 68-2-54 Ta

Solder head resistance
up to 260°C 10 sec. acc. IEC 68-2-20 Tb

Mechanical life > 500 cycles

Rated voltage 100 V_{RMS}/150 VDC

Insulation resistance > 10¹⁰ Ω

Air and creepage distance >0.6 mm

Current carrying capacity per contact 1 A

Moisture sensibility level (MSL)
J-STD-020C Level 1

RoHS-conform

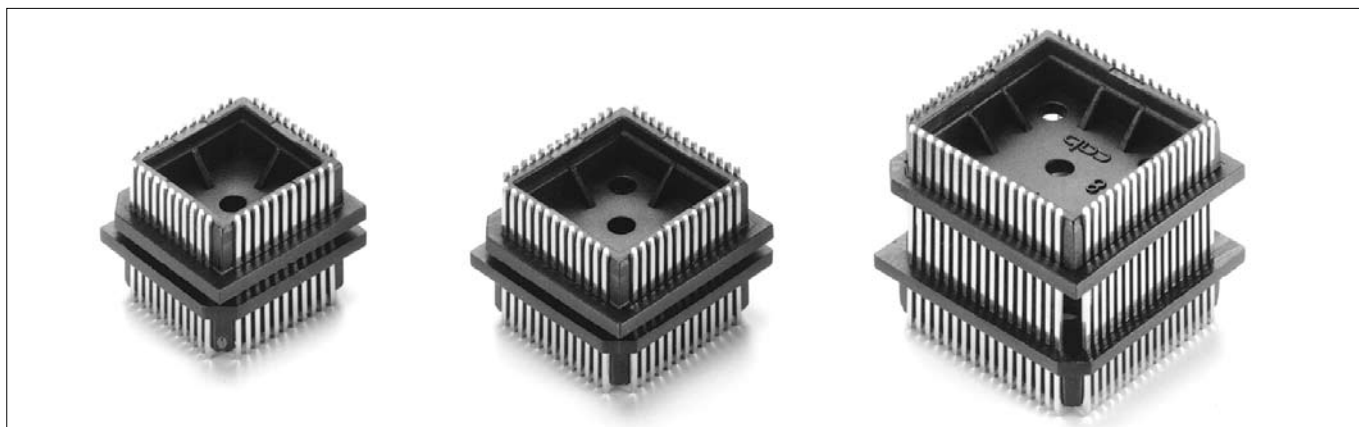

Customer specific design

Length: A = _____
K = 4.6 mm 5.5 mm

Surface: tinned
 gold plated 0.15 µm
 gold plated 0.75 µm

Pin count: _____

Single contact pins stock items

A	Gold 0.15 µm		
15.2	x		
16.5	x		
17.8	x		
19.1	x		
19.8	x		
21.6	x		
24.1	x		
26.7	x		
29.2	x		
Custom lengths and surface finishes for 60,000 pins or more			

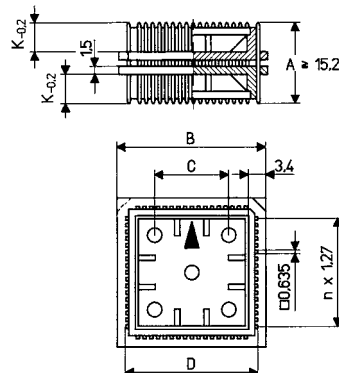

			A	15.2	21.6		
			K	5.5	5.5		
B	C	D	Pins	Part No. Contact pin 0.15 µm gold plated			
12.8		9.8	20				
15.3		12.3	28	3306813	3306913		
15.3		12.3	32	3306823	3306923		
18.0		14.9	32				
20.3		17.4	44	3306833	3306933		
23.0	9.5	19.9	52	3306843	3306943		
28.0	14.0	25.0	68	3306853	3306953		
33.0	17.8	30.1	84	3306863	3306963		

QFP-Socket Cover Series Q2101

QFP-Base Socket Series Q2001

Content of delivery Series Q2101

QFP-Socket cover and 4 screws M2x6

Content of delivery Series Q2001

QFP-Base socket and a cross slot screwdriver for M2

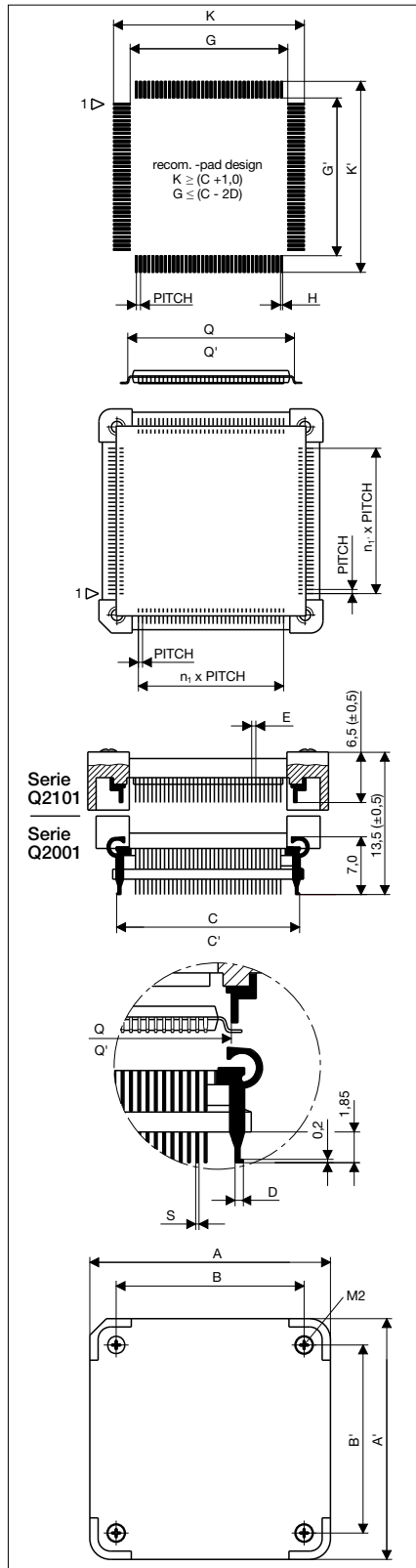

Contact

Beryllium copper, nickel 1-3 µm,
Q2101 = gold 0.5 µm, Q2001 = gold 0.25 µm

Insulator body

Liquid cristall polymer (LCP) self-extinguishing
rated UL94V0

Operation temperature -25 up to +85°C

Resistance to solder heat

Reflow 260°C, 10 sec.
Manual 350°C, 5 sec./
per contact

Mechanical life >100 cycles

Rated voltage 100 V_{RMS}/150 VDC

Contact resistance < 70 mΩ

Insulation resistance > 5 x 10⁸ Ω

Current carrying capacity per contact 0,5 A

Moisture sensibility level (MSL)

J-STD-020C Level 2

RoHS-conform

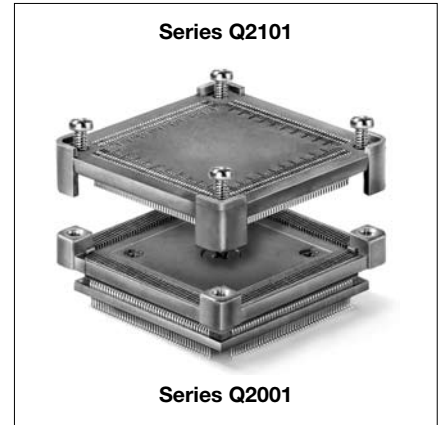

											Q2001		Q2101	
											S=Square R=Rectangular		Part No.	
A	B	C	D	E	H	Q	S	n ₁	n ₁ '	Pitch	Pins			
A'	B'	C'				Q'								
19.00	12.65	12.1	0.5	0.18	0.2	11.22	0.18	19	0.4	80	S	3303231	3303275	
21.00	14.65	14.1	0.5	0.18	0.2	13.20	0.18	24	0.4	100	S	3303232	3303276	
23.00	16.60	16.0	0.5	0.18	0.2	15.42	0.18	29	0.4	120	S	3303233	3303277	
21.00	16.95	16.1	0.5	0.20	0.25	15.22	0.18	31	0.4	128	S	3303264	3303314	
25.00	18.65	18.1	0.5	0.20	0.2	17.22	0.18	35	0.4	144	S	3303234	3303278	
23.55	17.20	16.1				15.40		31						
29.55	23.20	22.1	0.5	0.18	0.2	21.40	0.18	45	0.4	156	R	3303235	3303279	
29.00	22.65	22.1	0.5	0.20	0.2	21.20	0.18	43	0.4	176	S	3303236	3303280	
33.00	26.65	26.1	0.5	0.20	0.2	25.22	0.18	53	0.4	216	S	3303324	3303321	
37.50	31.15	30.6	0.5	0.18	0.2	30.00	0.18	63	0.4	256	S	3303237	3303281	
17.00	10.65	9.1	0.5	0.23	0.25	8.40	0.18	11	0.5	48	S	3303238	3303282	
19.00	12.65	12.1	0.5	0.25	0.25	11.20	0.18	15	0.5	64	S	3303267	3303318	
21.00	14.65	14.1	0.5	0.25	0.25	13.40	0.18	19	0.5	80	S	3303239	3303283	
23.00	16.60	16.0	0.5	0.23	0.25	15.12	0.18	24	0.5	100	S	3303240	3303284	
29.00	22.65	22.05	0.5	0.25	0.25	21.20	0.18	29	0.5	120	S	3303241	3303285	
29.00	22.65	22.05	0.5	0.25	0.25	21.80	0.18	29	0.5	120	S	3303241	3303286	
24.00	17.65	16.1				15.40		25						
30.00	23.65	21.1	0.5	0.25	0.25	21.40	0.18	37	0.5	128	R	3303243	3303287	
27.00	20.65	20.1	0.5	0.25	0.25	19.40	0.18	31	0.5	128	S	3303242	3303288	
29.00	22.65	22.05	0.5	0.25	0.25	21.20	0.18	35	0.5	144	S	3303244	3303289	
33.00	26.65	26.1	0.5	0.23	0.25	25.24	0.18	39	0.5	160	S	3303245	3303290	
23.00	26.65	26.1	0.5	0.23	0.25	25.24	0.18	43	0.5	176	S	3303246	3303291	
37.00	30.65	30.1	0.5	0.23	0.25	29.40	0.18	51	0.5	208	S	3303247	3303292	
37.00	30.65	30.1	0.5	0.23	0.25	30.00	0.18	51	0.5	208	S	3303247	3303293	
41.00	34.65	34.1	0.5	0.25	0.25	33.90	0.18	59	0.5	240	S	3303248	3303294	
19.70	13.35	12.2	0.5	0.25	0.35	11.2	0.23	11	0.65	48	S	3303325	3303322	
19.70	13.35	12.2	0.5	0.25	0.35	11.2	0.23	12	0.65	52	S	3303268	3303319	
19.70	13.35	12.2	0.5	0.25	0.35	11.2	0.23	13	0.65	56	S	3303359	3303323	
22.10	15.75	14.6	0.8	0.25	0.35	13.95	0.23	15	0.65	64	S	3303249	3303295	
24.10	17.75	16.6	0.8	0.25	0.35	15.80	0.23	19	0.65	80	S	3303250	3303296	
24.10	17.75	16.6	0.8	0.25	0.35	15.35	0.23	19	0.65	80	S	3303250	3303297	
23.75	17.40	16.25				16.57		19						
30.25	23.90	22.75	0.5	0.25	0.35	23.07	0.25	29	0.65	100	R	3303251	3303298	
23.75	17.40	16.25				15.35		19						
30.25	23.90	22.75	0.5	0.25	0.35	21.25	0.25	29	0.65	100	R	3303251	3303299	
23.75	17.40	16.25				15.91		19						
30.25	23.90	22.75	0.5	0.25	0.35	21.85	0.25	29	0.65	100	R	3303251	3303300	
23.75	17.40	16.25				16.77		19						
30.25	23.90	22.75	0.5	0.25	0.35	23.07	0.25	29	0.65	100	R	3303251	3303301	
28.10	21.75	20.6	0.8	0.25	0.35	21.00	0.23	24	0.65	100	S	3303252	3303302	
29.60	23.25	22.1	0.5	0.25	0.35	21.40	0.23	27	0.65	112	S	3303263	3303313	
29.60	23.25	22.1	0.5	0.25	0.35	21.1	0.23	28	0.65	116	S	3303269	3303320	
38.70	31.70	30.6	0.8	0.23	0.35	30.30	0.23	35	0.65	144	S	3303253	3303303	
38.70	31.70	30.6	0.8	0.23	0.35	30.30	0.23	39	0.65	160	S	3303254	3303304	
38.70	31.70	30.6	0.8	0.23	0.35	30.30	0.23	41	0.65	168	S	3303255	3303305	
16.70	10.35	9.20	0.5	0.25	0.5	8.40	0.25	7	0.8	32	S	3303265	3303316	
19.70	13.35	12.2	0.5	0.5	0.5	11.20	0.25	10	0.8	44	S	3303260	3303311	
19.70	13.35	13.3	0.75	0.25	0.5	12.22	0.23	10	0.8	44	S	3303261	3303312	
23.70	17.35	17.3	0.75	0.25	0.5	16.20	0.30	15	0.8	64	S	3303256	3303306	
23.70	17.35	16.2	0.5	0.25	0.5	15.20	0.25	15	0.8	64	S	3303262	3303307	
23.70	17.35	17.3				16.20		15						
30.10	23.75	23.3	0.75	0.25	0.5	22.40	0.30	23	0.8	80	R	3303257	3303308	
23.70	17.35	17.3				15.96		15						
30.10	23.75	23.3	0.75	0.25	0.5	22.00	0.30	23	0.8	80	R	3303257	3303309	
23.80	17.45	17.2				16.60		12						
29.80	23.45	23.2	0.75	0.25	0.6	22.60	0.30	18	1.0	64	R	3303259	3303310	

Please check **Dimension Q** because several versions are available.

Content of delivery

QFP-Solder base adapter, core pin

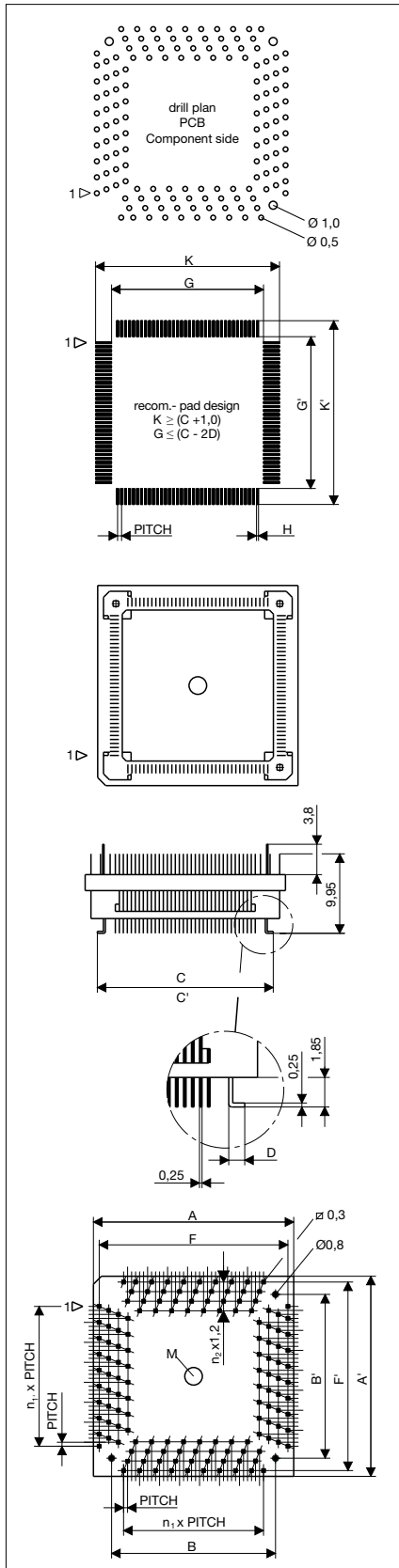

Contact

NiFe (42 alloy) nickel 1-3 µm, gold 0.25 µm

Insulator body

Liquid Crystall Polymer (LCP) self-extinguishing rated UL94V0

Operation temperature -25 up to +85°C

Resistance to solder heat

Reflow 260°C, 10 sec.
Manual 350°C, 5 sec./per contact

Rated voltage

100 V_{RMS}/150 VDC

Contact resistance

< 70 mΩ

Insulation resistance

> 5 x 10⁸ Ω

Current carrying capacity per contact 0,5 A

Moisture sensibility level (MSL)

J-STD-020C Level 2

RoHS-conform

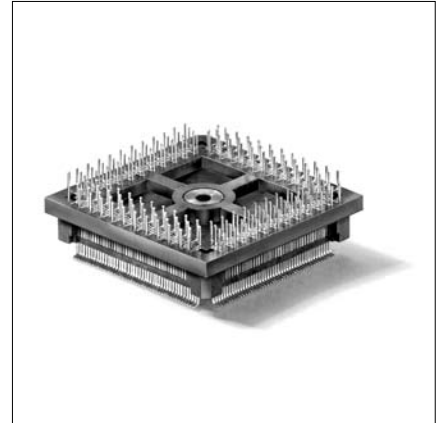

A	B	C	D	F	H	M	n ₁	n ₂	Pitch	Pins	S=Square R=Rectangular	Variant	Part No.
12.00	7.77	9.0	1.005	10.84	0.25	∅ 2,2	11	2	0.5	48	S	01	3303001
14.00	9.77	12.0	1.505	12.84	0.25	M2	15	3	0.5	64	S	01	3303002
15.00	10.77	12.0	1.005	13.84	0.25	M2	17	3	0.5	72	S	01	3303003
16.00	11.77	14.0	1.505	14.84	0.25	M2	19	3	0.5	80	S	01	3303004
19.55	15.00	16.5	1.125	18.10	0.25	M2	24	3	0.5	100	S	01	3303005
21.00	16.77	18.0	1.005	19.84	0.25	M2	29	3	0.5	120	S	01	3303006
25.05	20.50	22.0	1.125	23.60	0.25	M2	29	3	0.5	120	S	02	3303007
19.00	14.77	16.0	1.005	17.84	0.25	M2	25	3	0.5	128	R	01	3303008
25.00	20.77	22.0	1.125	23.60	0.25	M2	35	3	0.5	144	S	01	3303009
29.05	24.50	26.0	1.125	27.60	0.25	M2	39	3	0.5	160	S	01	3303010
29.05	24.50	26.0	1.125	27.60	0.25	M2	43	3	0.5	176	S	01	3303011
33.05	28.50	30.0	1.125	31.60	0.25	M3	51	3	0.5	208	S	01	3303012
32.00	27.77	29.2	1.105	30.84	0.25	M3	51	3	0.5	256	R	01	3303013
44.00	39.77	41.2	1.105	42.84	0.25	M3	75	3	0.5	256	R	01	3303013
30.55	26.02	27.5	1.125	29.10	0.35	M3	32	3	0.635	132	S	01	3303014
12.5	8.10	9.0	0.9	11.05	0.35	∅ 2,2	9	2	0.65	40	S	01	3303365
14.45	9.92	12.0	1.425	13.00	0.35	M2	12	2	0.65	52	S	01	3303015
15.10	10.57	12.5	1.350	13.65	0.35	M2	13	2	0.65	56	S	01	3303016
16.40	11.85	14.0	1.450	14.95	0.35	M2	15	3	0.65	64	S	01	3303017
19.00	14.47	16.0	1.150	17.55	0.35	M2	19	3	0.65	80	S	01	3303018
19.00	14.47	15.96	1.125	17.55	0.35	M2	19	3	0.65	100	R	01	3303019
25.50	20.97	22.45	1.125	24.05	0.35	M2	29	3	0.65	100	R	01	3303019
25.30	21.40	22.0	1.000	23.85	0.35	M2	27	3	0.65	112	S	01	3303020
32.00	27.47	30.0	1.650	30.55	0.35	M3	35	3	0.65	144	S	02	3303034
32.00	27.47	30.0	1.650	30.55	0.35	M3	39	3	0.65	160	S	02	3303021
35.90	31.37	34.0	1.700	34.45	0.35	M3	45	3	0.65	184	S	01	3303022
12.25	7.72	9.2	1.125	10.80	0.5	∅ 2,3	7	2	0.8	32	S	01	3303023
14.65	10.12	12.0	1.325	13.20	0.5	M2	10	2	0.8	44	S	01	3303024
15.45	10.92	12.0	0.925	14.00	0.5	M2	11	3	0.8	48	S	01	3303026
18.65	14.12	16.0	1.325	17.20	0.5	M2	15	3	0.8	64	S	01	3303027
18.65	14.10	16.0	1.125	17.20	0.5	M2	15	3	0.8	80	R	01	3303028
25.05	20.50	22.0	1.125	23.60	0.5	M2	23	3	0.8	80	R	01	3303028
25.85	21.32	24.0	1.725	24.40	0.5	M2	24	3	0.8	100	S	01	3303029
31.45	26.92	31.4	2.625	30.00	0.5	M2	29	3	0.8	120	S	01	3303030
31.45	26.92	31.4	2.625	30.00	0.5	M2	31	3	0.8	128	S	01	3303031
17.05	12.12	16.4	2.325	15.60	0.6	M2	10	2	1.0	44	S	01	3303032
19.05	14.12	16.0	1.125	17.60	0.6	M2	12	3	1.0	64	R	01	3303033
25.05	20.12	22.0	1.125	23.60	0.6	M2	18	3	1.0	64	R	01	3303033

QFP-Extender Series Q1501 Q1502

By using the QFP-Extender the user can build up his individual height.

Contact clip

Beryllium copper, nickel 2.5 µm, gold flash

Sleeve

Screw machin. brass, nickel 2.5 µm, gold flash

PCB

Glas-fibre Epoxyd EP-GC 02, self-extinguishing rated UL94V0

Operation temperature -55 up to +125°C

Resit. to wave solder heat 260°C, 5 sec.

Mechanical lifte > 500 cycles

Rated voltage 100 V_{RMS}/150 VDC

Contact resistance < 20 mΩ

Insulation resistance > 5 x 10⁹ Ω

Current carrying capacity per contact 0,4 A
RoHS-conform

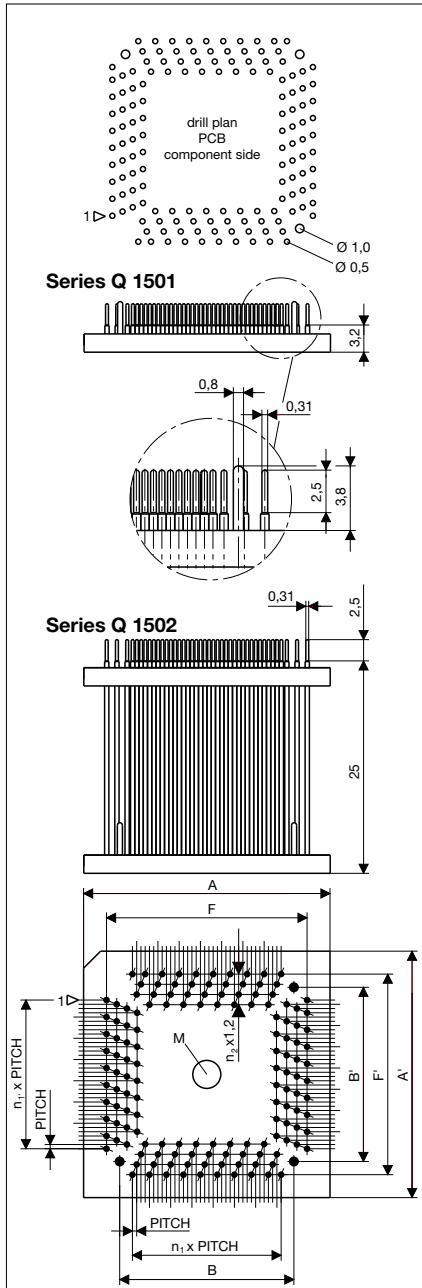
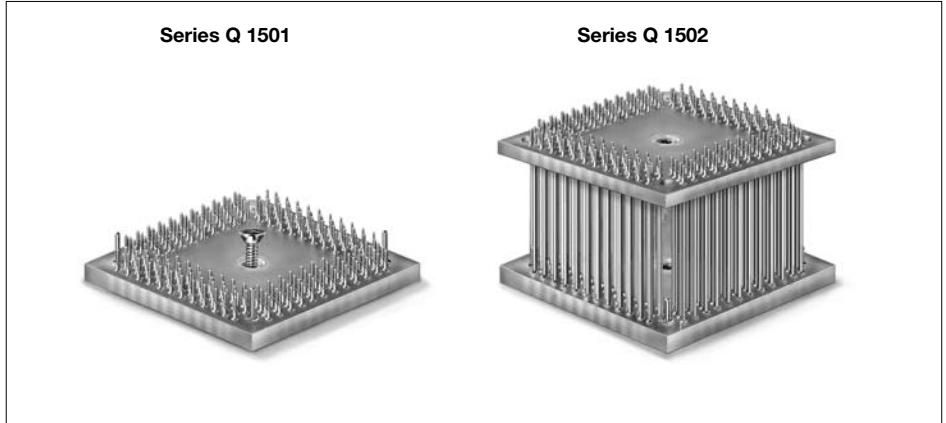

A A'	B B'	F F'	M	n ₁ n ₁ '	n ₂	Pitch	Pins	S=Square R=Rectangular	Variant	Q 1501	Q 1502
										Part No.	
19.0	7.77	10.84	∅ 2,2	11	2	0.5	48	S	01	3303043	3303090
16.0	9.77	12.84	M2	15	3	0.5	64	S	01	3303044	3303091
17.0	10.77	13.84	M2	17	3	0.5	72	S	01	3303045	3303092
18.0	11.77	14.84	M2	19	3	0.5	80	S	01	3303046	3303093
21.5	15.00	18.10	M2	24	3	0.5	100	S	01	3303047	3303094
23.0	16.77	19.84	M2	29	3	0.5	120	S	01	3303048	3303095
29.0	20.50	23.60	M2	29	3	0.5	120	S	02	3303049	3303096
24.0	14.77	17.84	M2	25	3	0.5	128	R	01	3303050	3303097
30.0	20.77	23.84	M2	37	3	0.5	144	S	01	3303051	3303098
27.0	20.50	23.60	M2	35	3	0.5	144	S	01	3303052	3303099
33.0	24.50	27.60	M2	39	3	0.5	160	S	01	3303053	3303100
33.0	24.50	27.60	M2	43	3	0.5	176	S	01	3303054	3303101
37.0	28.50	31.60	M3	51	3	0.5	208	S	01	3303054	3303101
34.0	27.77	30.84	M3	51	3	0.5	256	R	01	3303055	3303102
46.0	39.77	42.84	M3	75	3	0.5	256	R	01	3303055	3303102
32.5	26.02	29.10	M3	32	3	0.635	132	S	01	3303056	3303103
12.5	-	-	-	-	-	0.65	40	S	01	3303473	3303474
16.5	9.92	13.00	M2	12	2	0.65	52	S	01	3303057	3303104
17.0	10.57	13.65	M2	13	2	0.65	56	S	01	3303058	3303105
22.0	11.85	14.95	M2	15	3	0.65	64	S	01	3303059	3303106
24.0	14.47	17.55	M2	19	3	0.65	80	S	01	3303060	3303107
23.0	14.47	17.55	M2	19	3	0.65	100	R	01	3303061	3303108
29.5	20.97	24.05	M2	29	3	0.65	112	S	01	3303062	3303109
25.3	21.40	23.85	M2	27	3	0.65	144	S	02	3303075	3303122
34.0	27.47	30.55	M3	35	3	0.65	160	S	02	3303063	3303110
34.0	27.47	30.55	M3	39	3	0.65	184	S	01	3303064	3303111
38.0	31.37	34.45	M3	45	3	0.65	184	S	01	3303064	3303111
16.5	7.72	10.80	∅ 2,3	7	2	0.8	32	S	01	3303065	3303112
19.7	10.12	13.20	M2	10	2	0.8	44	S	01	3303066	3303113
17.5	10.92	14.00	M2	11	3	0.8	48	S	01	3303067	3303114
23.7	14.12	17.20	M2	15	3	0.8	64	S	01	3303068	3303115
23.7	14.10	17.20	M2	15	3	0.8	80	R	01	3303069	3303116
30.0	20.50	23.60	M2	23	3	0.8	80	R	01	3303069	3303116
27.8	21.32	24.40	M2	24	3	0.8	100	S	01	3303070	3303117
33.5	26.92	30.00	M2	29	3	0.8	120	S	01	3303071	3303118
33.5	26.92	30.00	M2	31	3	0.8	128	S	01	3303072	3303119
19.0	12.12	15.60	M2	10	2	1.0	44	S	01	3303073	3303120
23.8	14.12	17.60	M2	12	3	1.0	64	R	01	3303074	3303121
29.8	20.12	23.60	M2	18	3	1.0	64	R	01	3303074	3303121

Contents of delivery:
QFP-Extender, Counter-sunk screw

31 QFP-Adapter Series Q2201

Contact

Beryllium copper, nickel 1-3 µm, gold 0.5 µm

Insulator body

Liquid Crystall Polymer (LCP) self-extinguishing rated UL94V0

Operation temperature -25 up to +85°C

Resistance to solder heat

Reflow 260°C, 10 sec.
Manual 350°C, 5 sec./per contact

Rated voltage 100 V_{RMS}/150 VDC

Contact resistance < 70 mΩ

Insulation resistance > 5 x 10⁸Ω

Current carrying capacity per contact 0,5 A

Moisture sensibility level (MSL)

J-STD-020C Level 2

RoHS-conform

Contents of delivery

QFP-Adapter, 4 cross slot screws M2x10



	A A'	B B'	F F'	J	n ₂	n ₁ n ₁ '	Pitch	Pins	S=Square R=Rectangular	Variant	Part No.
	19.00	12.65	12.65	1.3	3	19	0.4	80	S	01	3303326
	21.00	14.65	14.65	1.3	3	24	0.4	100	S	01	3303327
	23.00	16.60	16.60	1.3	3	29	0.4	120	S	01	3303328
	23.00	16.95	19.70	1.3	3	31	0.4	128	S	01	3303035
	25.00	18.65	21.70	1.3	3	35	0.4	144	S	01	3303329
	23.55	17.20	18.65	1.3	3	31	0.4	156	R	01	3303330
	29.55	23.20	17.20			45					
	29.00	22.65	23.30	1.3	3	43	0.4	176	S	01	3303331
	33.00	26.65	29.70	1.3	3	53	0.4	216	S	01	3303360
	37.50	31.15	31.15	1.3	3	63	0.4	256	S	01	3303332
	17.00	10.65	10.84	1.2	2	11	0.5	48	S	01	3303333
	19.00	12.65	12.84	1.2	3	15	0.5	64	S	01	3303358
	21.00	14.65	15.84	1.2	3	19	0.5	80	S	02	3303334
	23.00	16.60	18.10	1.2	3	24	0.5	100	S	01	3303335
	29.00	22.65	23.60	1.2	3	29	0.5	120	S	02	3303336
	24.00	17.65	17.84	1.2	3	25	0.5	128	R	01	3303337
	30.00	23.65	23.84			37					
	27.00	20.65	22.60	1.2	3	31	0.5	128	S	01	3303338
	29.00	22.65	23.60	1.2	3	35	0.5	144	S	01	3303339
	33.00	26.65	27.60	1.2	3	39	0.5	160	S	01	3303340
	33.00	26.65	27.60	1.2	3	43	0.5	176	S	01	3303341
	37.00	30.65	31.60	1.2	3	51	0.5	208	S	01	3303342
	41.00	34.65	36.20	1.2	3	59	0.5	240	S	01	3303343
	19.70	13.35	13.00	1.2	2	11	0.65	48	S	01	3303361
	19.70	13.35	13.00	1.2	2	12	0.65	52	S	01	3303363
	19.70	13.35	13.65	1.2	2	13	0.65	56	S	01	3303362
	22.10	15.75	14.95	1.2	3	15	0.65	64	S	01	3303344
	24.10	17.75	17.55	1.2	3	19	0.65	80	S	01	3303345
	23.75	17.40	17.55	1.2	3	19	0.65	100	R	01	3303346
	30.25	23.90	24.05			29					
	28.10	21.75	22.60	1.2	3	24	0.65	100	S	01	3303347
	29.60	23.25	23.85	1.2	3	27	0.65	112	S	01	3303356
	29.60	23.25	24.00	1.2	3	28	0.65	116	S	01	3303364
	38.70	31.70	33.30	1.2	3	35	0.65	144	S	01	3303348
	38.70	31.70	33.30	1.2	3	39	0.65	160	S	01	3303349
	38.70	31.70	33.30	1.2	3	41	0.65	168	S	01	3303350
	16.70	10.35	10.80	1.2	2	7	0.8	32	S	01	3303357
	19.70	13.35	13.20	1.2	3	10	0.8	44	S	01	3303354
	19.70	13.35	13.20	1.2	3	10	0.8	44	S	01	3303355*
	23.70	17.35	17.20	1.2	3	15	0.8	64	S	01	3303351
	23.70	17.35	17.20	1.2	3	15	0.8	80	R	01	3303352
	30.10	23.75	23.60			23					
	23.80	17.45	17.60	1.2	3	12	1.0	64	R	01	3303353
	29.80	23.45	23.60			18					

*for Base socket 3303261

QFP-Extender Series Q2501 Series Q2502

By using the QFP-Extender the user can build up his individual height.

Contact clip

Beryllium copper, nickel 2.5 µm, gold flash

Sleeve

Screw machin. brass, nickel 2.5 µm, gold flash

PCB

Glas-fibre Epoxyd EP-GC 02, self-extinguishing rated UL94V0

Operation temperature -55 up to +125°C

Resit. to wave solder heat 260°C, 5 sec

Mechanical lifte > 500 cycles

Rated voltage 100 V_{RMS}/150 VDC

Contact resistance < 20 mΩ

Insulation resistance > 5 x 10⁹ Ω

Current carrying capacity per contact 0,4 A
RoHS-conform

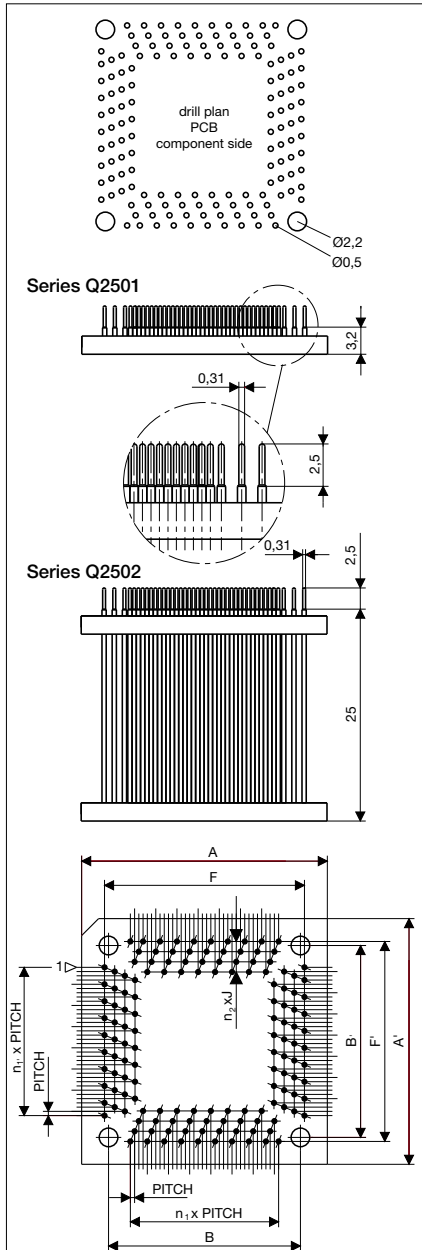
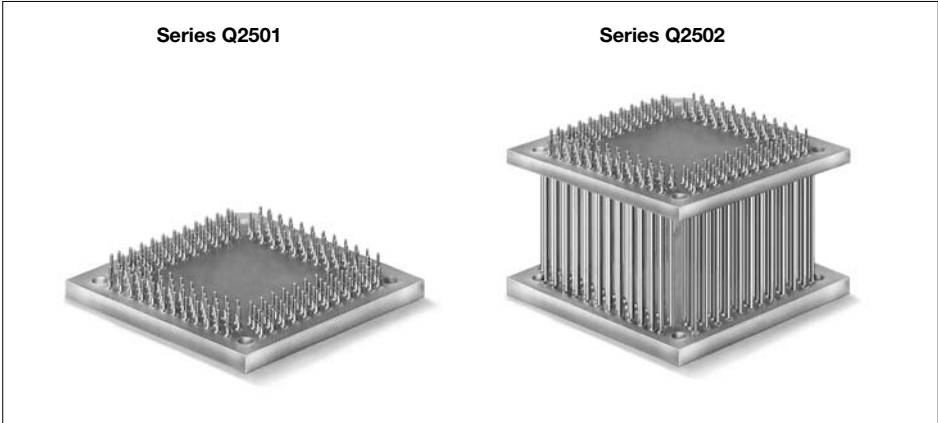

A A'	B B'	F	J	n ₂	n ₁	Pitch	Pins	S=Square R=Rectangular	Variant	Q2501	Q2502
										Part No.	
17.00	10.65	10.84	1.2	2	11	0.5	48	S	01	3303376	3303418
19.00	12.65	12.84	1.2	3	15	0.5	64	S	01	3303468	3303469
21.00	14.65	15,84	1.2	3	19	0,5	80	S	02	3303377	3303419
23.00	16.60	18.10	1.2	3	24	0,5	100	S	01	3303378	3303420
29.00	22.65	23.60	1.2	3	29	0.5	120	S	02	3303379	3303421
24.00	17.65	17.84	1.2	3	25	0.5	128	R	01	3303380	3303422
30.00	23.65	23.84	1.2	3	37	0.5	128	S	01	3303381	3303423
27.00	20.65	22.60	1.2	3	31	0.5	128	S	01	3303381	3303423
29.00	22.65	23.60	1.2	3	35	0.5	144	S	01	3303382	3303424
33.00	26.65	27.60	1.2	3	39	0.5	160	S	01	3303383	3303425
33.00	26.65	27.60	1.2	3	43	0.5	176	S	01	3303384	3303426
37.00	30.65	31.60	1.2	3	51	0.5	208	S	01	3303385	3303427
41.00	34.65	36.20	1.2	3	59	0.5	240	S	01	3303386	3303428
19.70	13.35	13.00	1.2	2	11	0.65	48	S	01	3303452	3303457
19.70	13.35	13.00	1.2	2	12	0.65	52	S	01	3303453	3303458
19.70	13.35	13.65	1.2	2	13	0.65	56	S	01	3303454	3303459
22.10	15.75	14.95	1.2	3	15	0.65	64	S	01	3303387	3303429
24.10	17.75	17.55	1.2	3	19	0.65	80	S	01	3303388	3303430
23.75	17.40	17.55	1.2	3	19	0.65	100	R	01	3303389	3303431
30.25	23.90	24.05	1.2	3	29	0.65	100	R	01	3303389	3303431
28.10	21.75	22.60	1.2	3	24	0.65	100	S	01	3303390	3303432
29.60	23.25	23.85	1.2	3	27	0.65	112	S	01	3303078	3303123
29.60	23.25	24.00	1.2	3	28	0.65	116	S	01	3303455	3303470
38.70	31.70	33.30	1.2	3	35	0.65	144	S	01	3303391	3303433
38.70	31.70	33.30	1.2	3	39	0.65	160	S	01	3303392	3303434
38.70	31.70	33.30	1.2	3	41	0.65	168	S	01	3303393	3303435
16.70	10.35	10.80	1.2	2	7	0.8	32	S	01	3303456	3303472
19.70	13.35	13.20	1.2	3	10	0.8	44	S	01	3303397	3303439
23.70	17.35	17.20	1.2	3	15	0.8	64	S	01	3303394	3303436
23.70	17.35	17.20	1.2	3	15	0.8	80	R	01	3303395	3303437
30.10	23.75	23.60	1.2	3	23	0.8	80	R	01	3303395	3303437
23.80	17.45	17.60	1.2	3	12	1.0	64	R	01	3303396	3303438
29.80	23.45	23.60	1.2	3	18	1.0	64	R	01	3303396	3303438

33 19" Laboratory cards FR4

L 4001 a

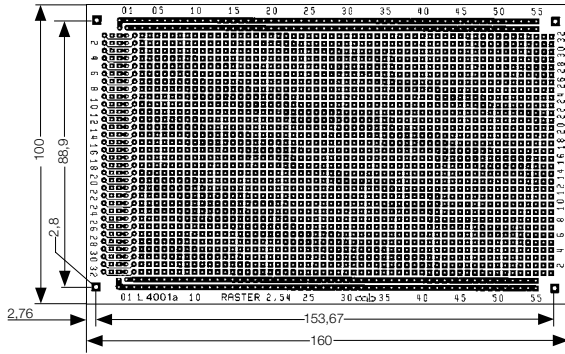

L 4003

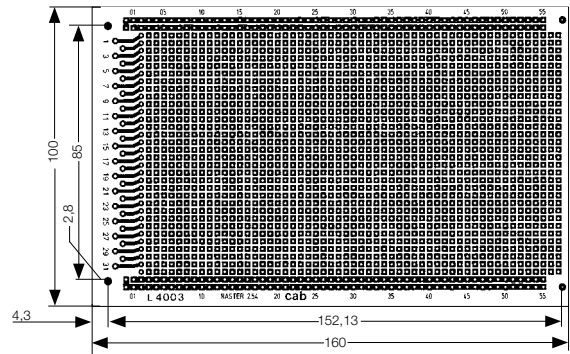

L 4005

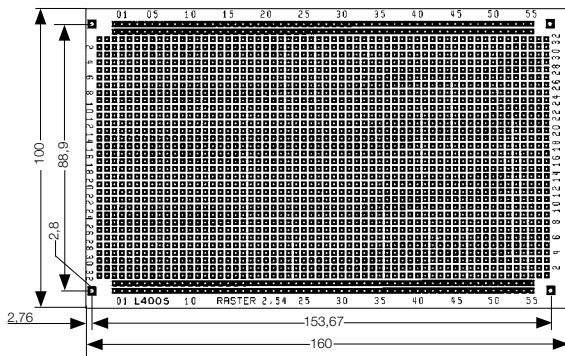

Type	Size mm	Plug type	Part No.
L 4001 a	100 x 160	B/C 64, C96	3250083
L 4003		31, DIN 41617	3250100
L 4005		all types	3250150

Base material: Glas fibre Epoxyd EP-GC 02, self-extinguishing rated UL94V0, (35 µm copper tinned Sn100 HAL)

Thickness: 1.6 ± 0,19 mm

Pitch: 2.54 x 2.54 mm

Drilled: 1.0 mm Ø

Operation temperature: -55 up to +125°C

RoHS-conform

Mounting print on the reverse side

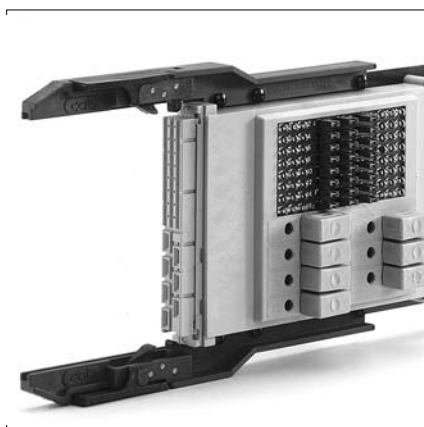

The Extender boards are RoHs-conform.

Signal measurement range

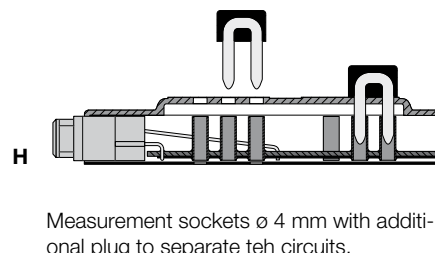
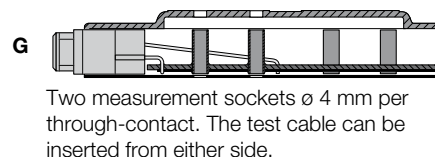
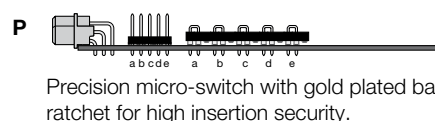
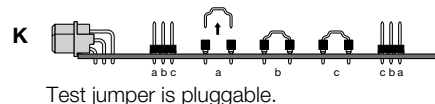
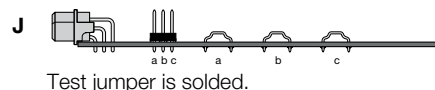

PCB

- 2 Double sided through- contacts
- 9 Multilayer 9-layer for fast signals



Guide rail

of short and compact construction
 Material: Thermoplastic polyester glass-fibre reinforced, self-extinguishing rated UL94V0
 Color: red
 Contents of delivery: Guide rail (upper) Guide rail (lower) Mounting hardware

Pull-in and disconnect level	PU	Part No.
with	1 Set	3300734
without	1 Set	3300735

Extender board	Height	PCB	t ₁ mm	A mm	B mm	Signal measurement range					
						J	K/P*	G	H		
C 64	3 HE	2	235	423	350		3370074				
C 96	3 HE	2	235	423	350	3370169	3370170				
F 48	3 HE	2	235	427	350	3370456	3370459				
E 160	3 HE	9	235	423	350			3371036*			
H 15	3 HE	2	175	367	290				3370492	3370493	
		2	235	423	350					3370497	
H7/F24	3 HE	2	175	367	290					3370532	3370533
		2	235	423	350						3370537
Joining adapter	Height	Plug connector		B mm	Part No.						
	6 HE	C, F		290 350	3300095 3300004						

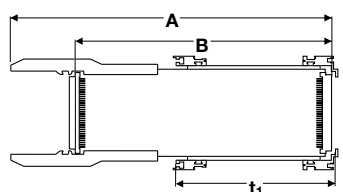



PLCC-Extractor

The secure extractor tool for all PLCC components from 20 up to 84 pins. It is universally suitable for PLCC sockets from all manufactures.

Compact

The supports are set to the external contours of the socket.

Durable

The two gripping hooks are made of special steel which has been hardened and the edges are rounded sharp-edged. Components can be extracted safely even from the SMD sockets.

Short-circuit safe

Due to separated supporting points of the pull-out hooks. Typ. surface resist. $10^5 \Omega$

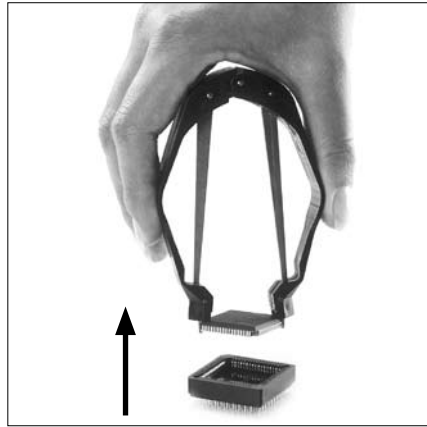

Description	Part No.
PLCC-Extractor	8920001

Easy to use

Insert each hook into the cut-cuts in the PLCC mounting.

Squeeze the grips together and the component can be gently extracted.

IC-Butler 2

The good value pin alignment tool for two IC width 0.3" and 0.6"

Conductive

Constructed from electrically conductive plastic Surface resistance $< 10^5 \Omega$

Antiskid

Four rubber feet

Alignment rollers

Adjustable, precision ball bearings.

Snap-fastener

\varnothing 4.0 and 10 mm for grounding of the appliance.



Description	Part No.
IC-Butler 2	8860010

Handling and adjustment

Guide the components between the alignment rollers

By turning the screw on the roll holder to the left or to the right the slot width can be changed.

IC-Butler 3

The special pin alignment tool for three IC-sizes 0.3" , 0.4" und 0.6"

Conductive

For MOS and CMOS components from 4 up to 48 pins.

Cost-effective

Particularly economic for production and storage

Robust

Metal work with four ball bearing alignment rollers.

Snap-fastener

\varnothing 4.0 mm for grounding the appliance.

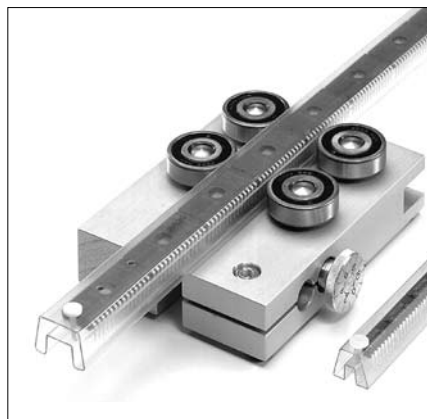

Description	Part No.
IC-Butler 3	8860025

Handling and adjustment

There are three notches on the axis for IC-widths 0.3" , 0.4" and 0.6" .

Adjustment with the knurled wheel so that the required width is visible on the notch.

Push through the packaging bar and check the result; readjust as long as the IC-components are perfectly in position. The scale serves as check instrument.

IC-Butler 5

The reasonable priced pin alignment tool for all IC widths

Conductive

Constructed from electrically conductive plastic Surface resistance $< 10^5 \Omega$

Antiskid

Four rubber feet

Alignment rollers

Adjustable, precision ball bearings.

Snap-fastener

\varnothing 4.0 and 10 mm for grounding of the appliance.



Benennung	Artikel-Nr.
IC-Butler 5	8860001

Handling and adjustment

Guide the components between the alignment rollers

By turning the screw on the roll holder to the left or to the right the slot width can be changed.

The further cab delivery program



PCB Magazines



PCB Separators



Minilift



Label Printer



Print and Apply



Marking Laser



cab Produkttechnik GmbH & Co KG

Postfach 19 04 D-76007 Karlsruhe
Wilhelm-Schickard-Str. D-76131 Karlsruhe

Telefon +49 721/66 26-222

Telefax +49 721/66 26-229

www.cab.de

E-Mail: info@cab.de

All specifications about delivery, design and technical data are given to the best of our current knowledge and are subject to change without prior notice.